

$$2 + 2 = 4$$

$$4 + 4 = 8$$

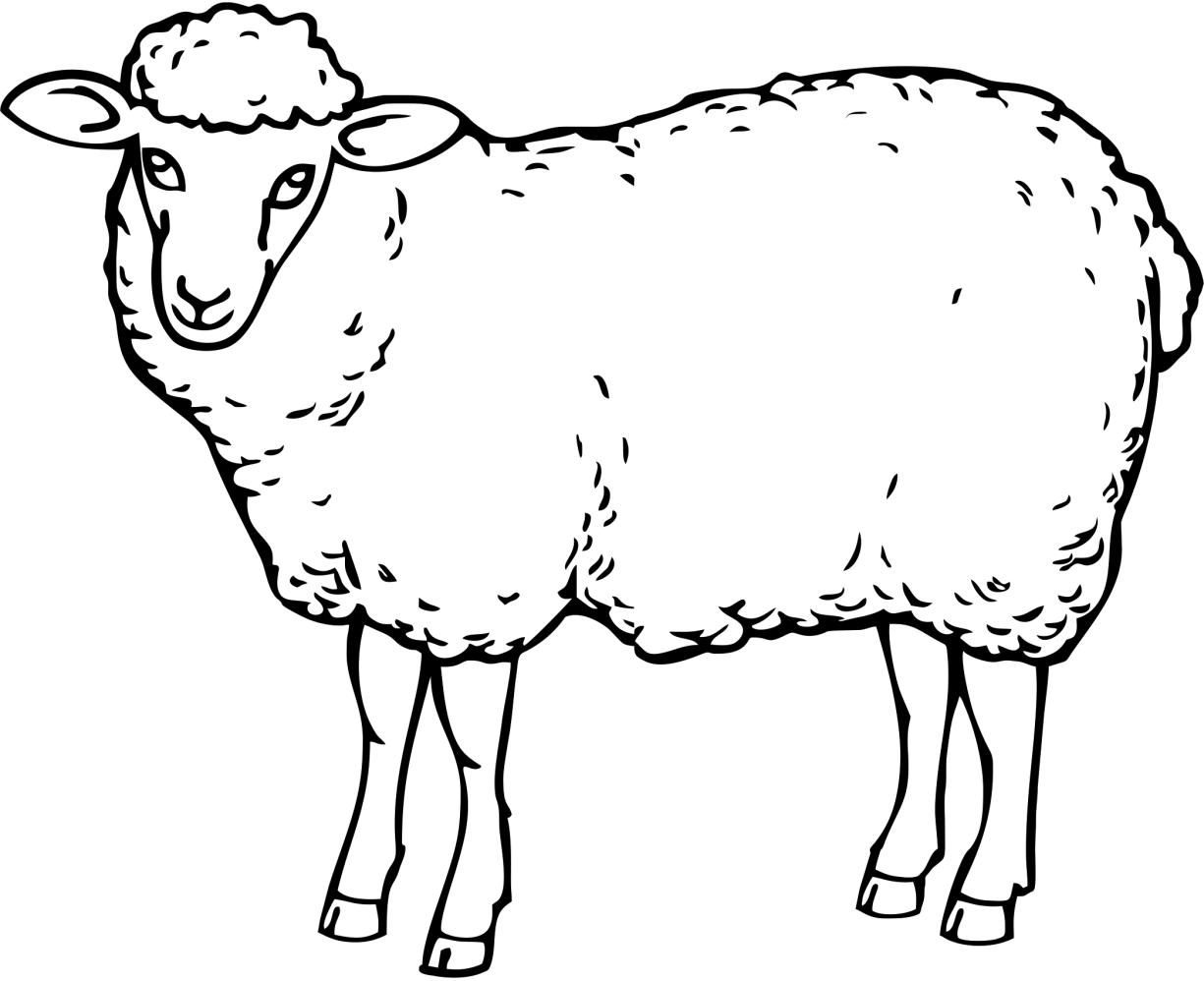

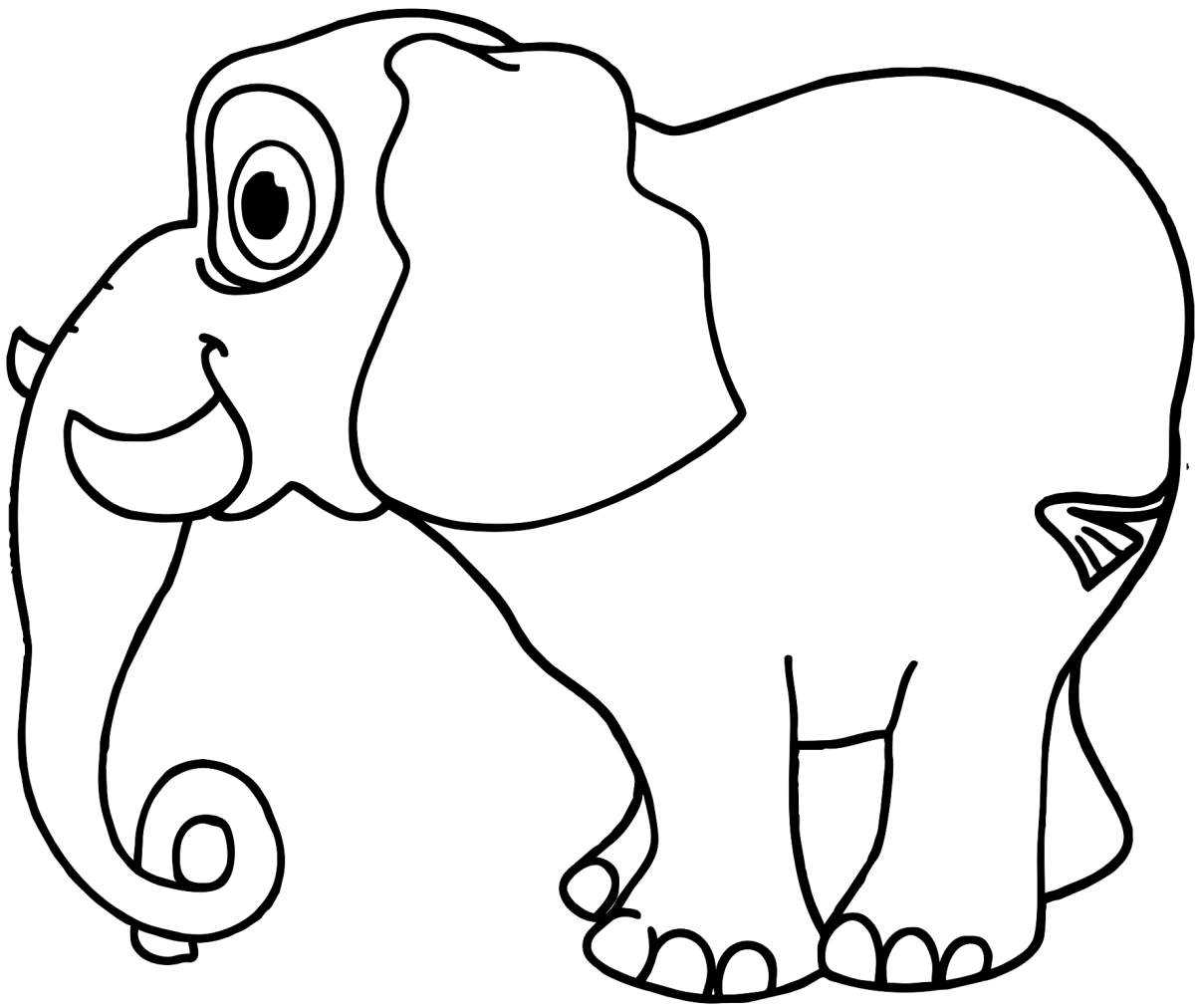

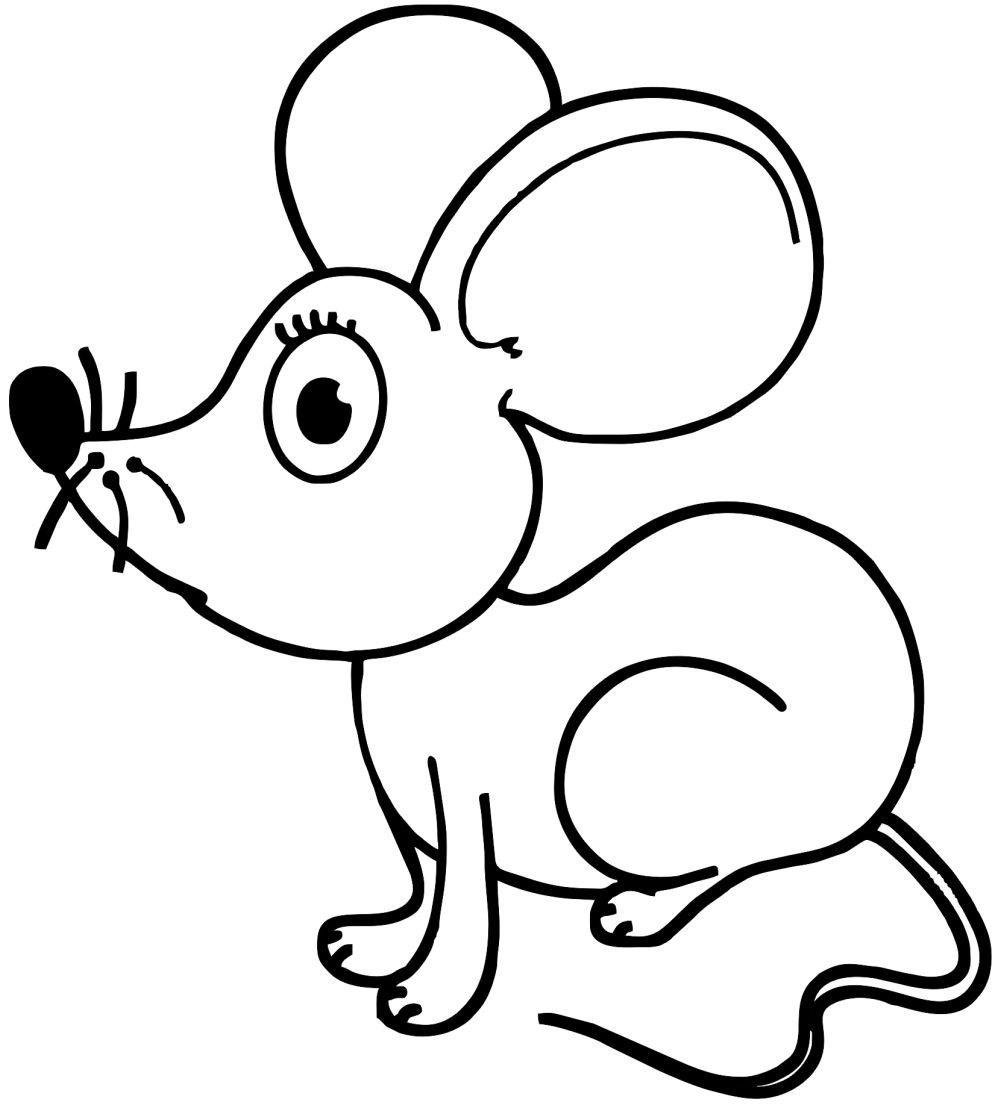



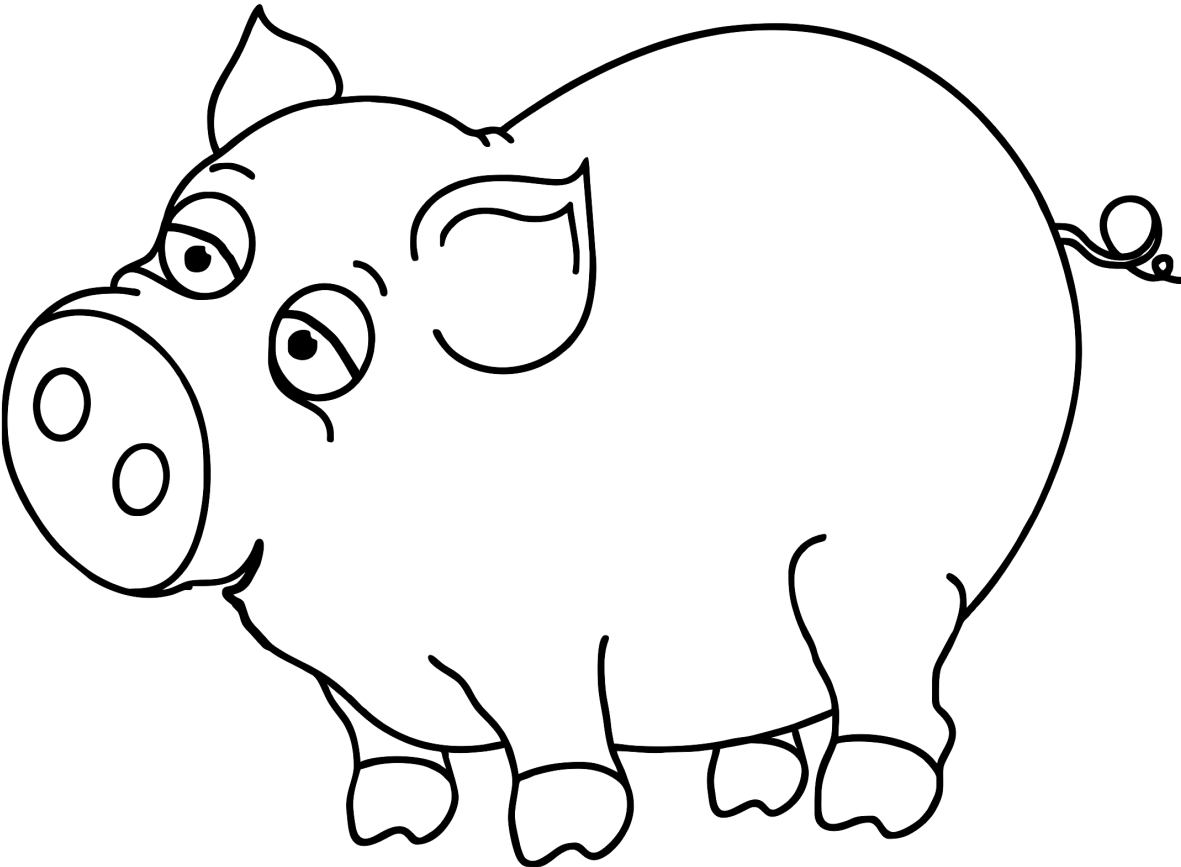

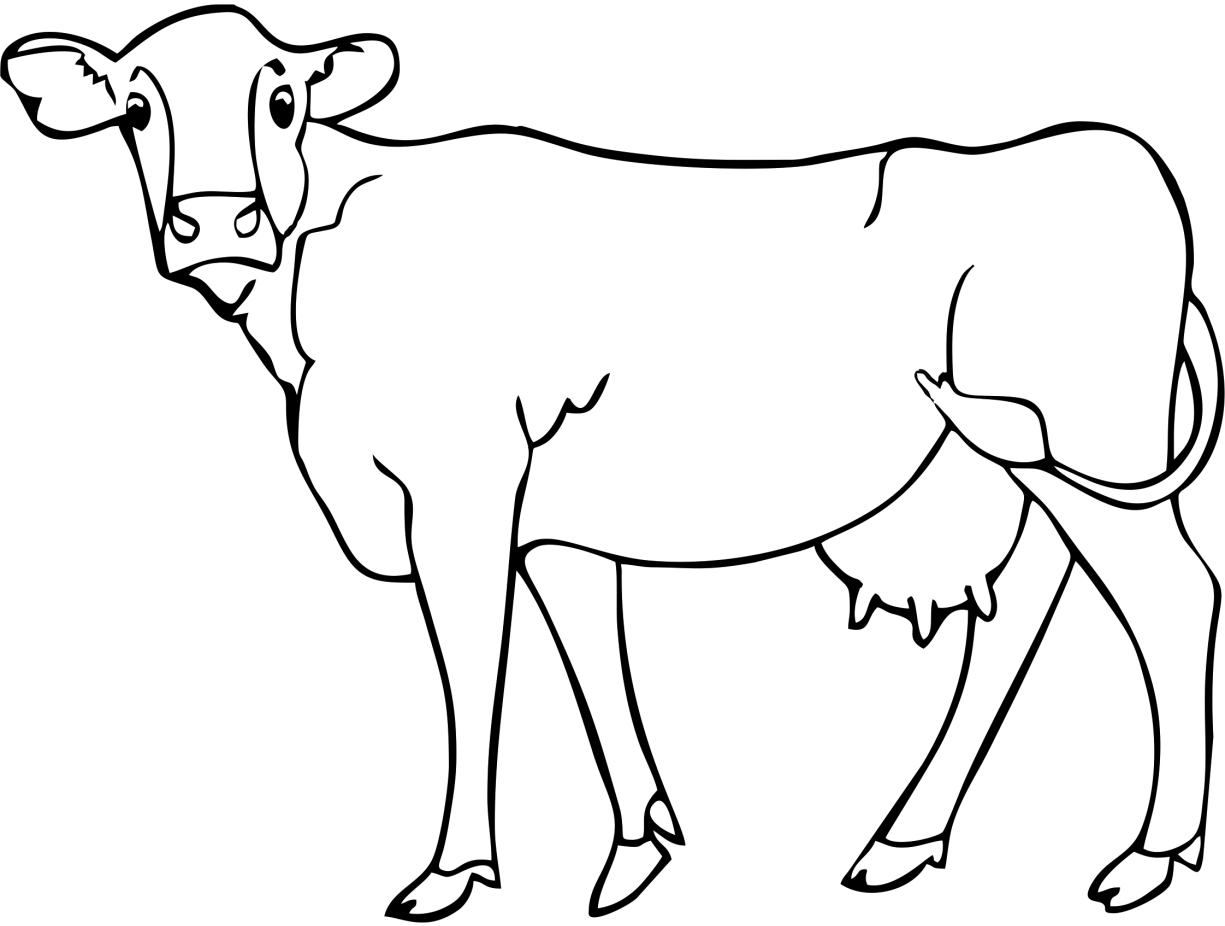

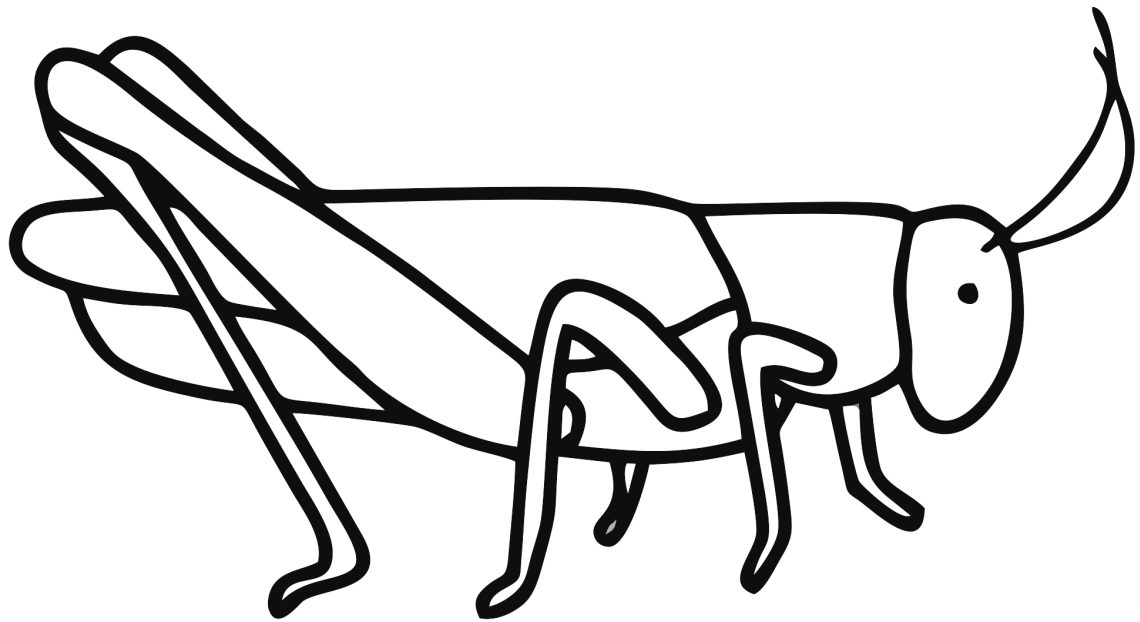

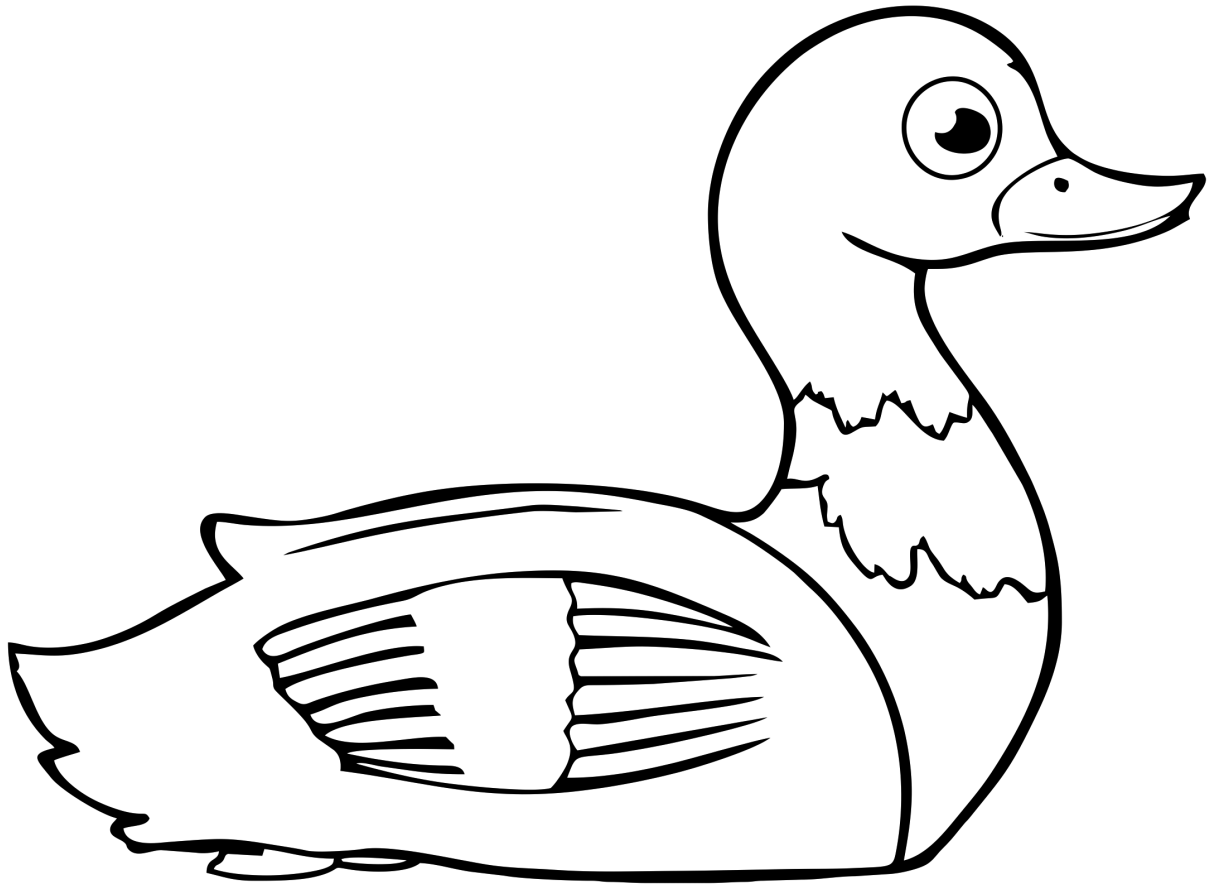

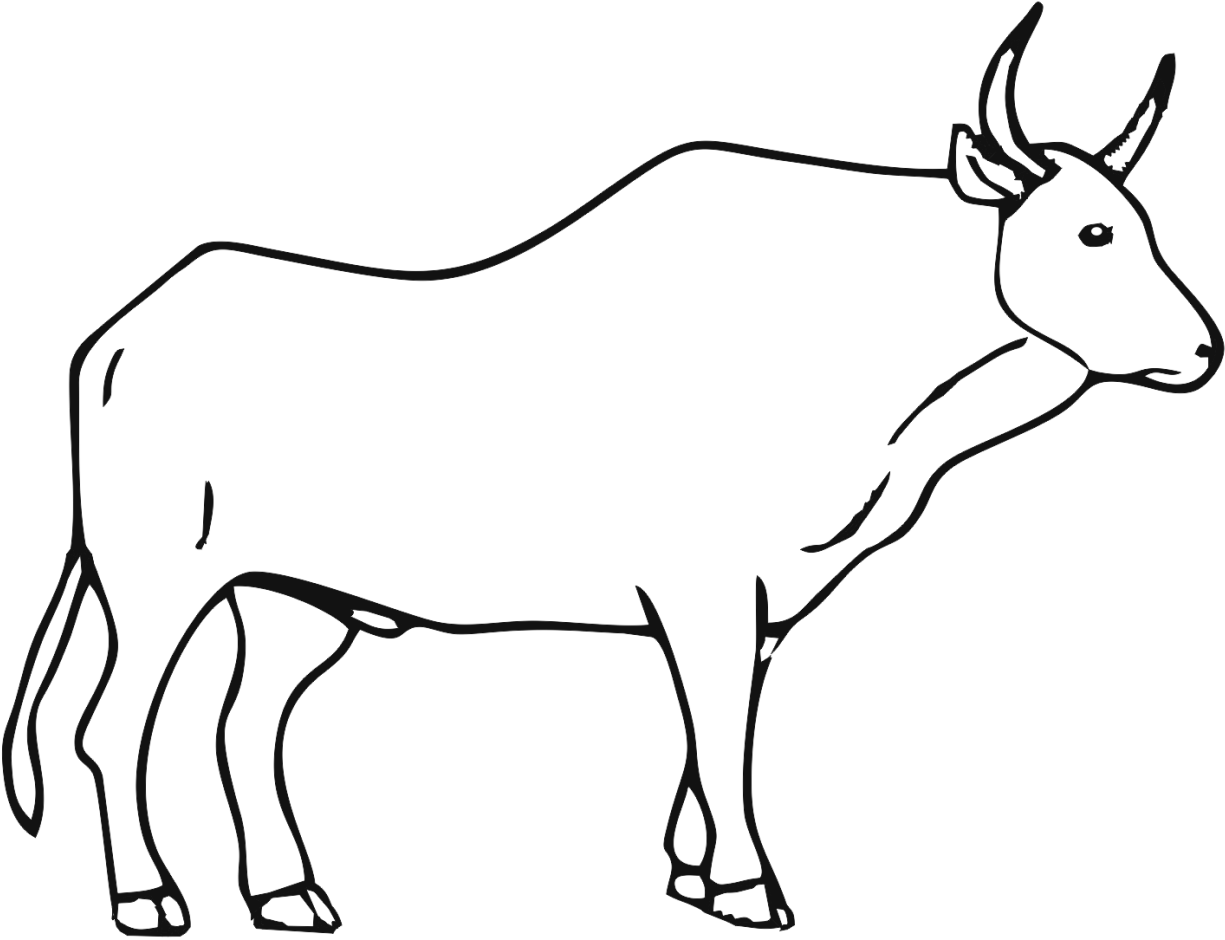



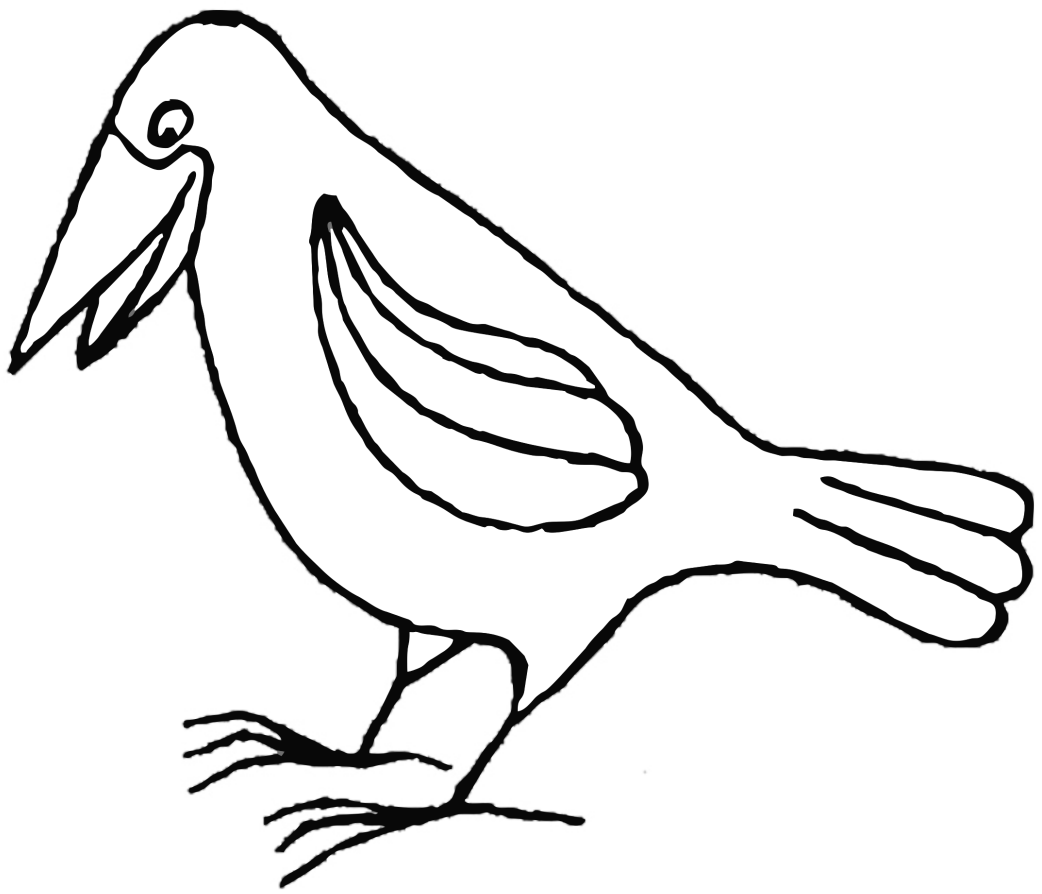

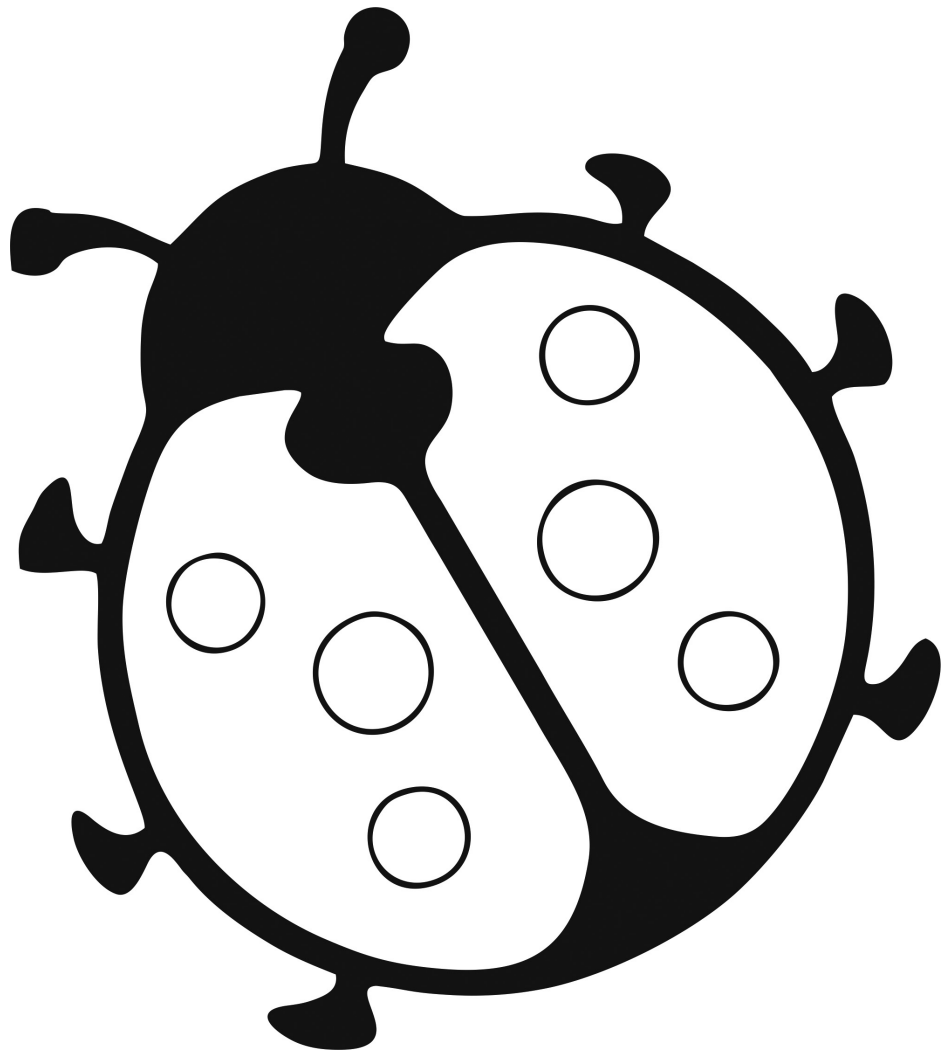





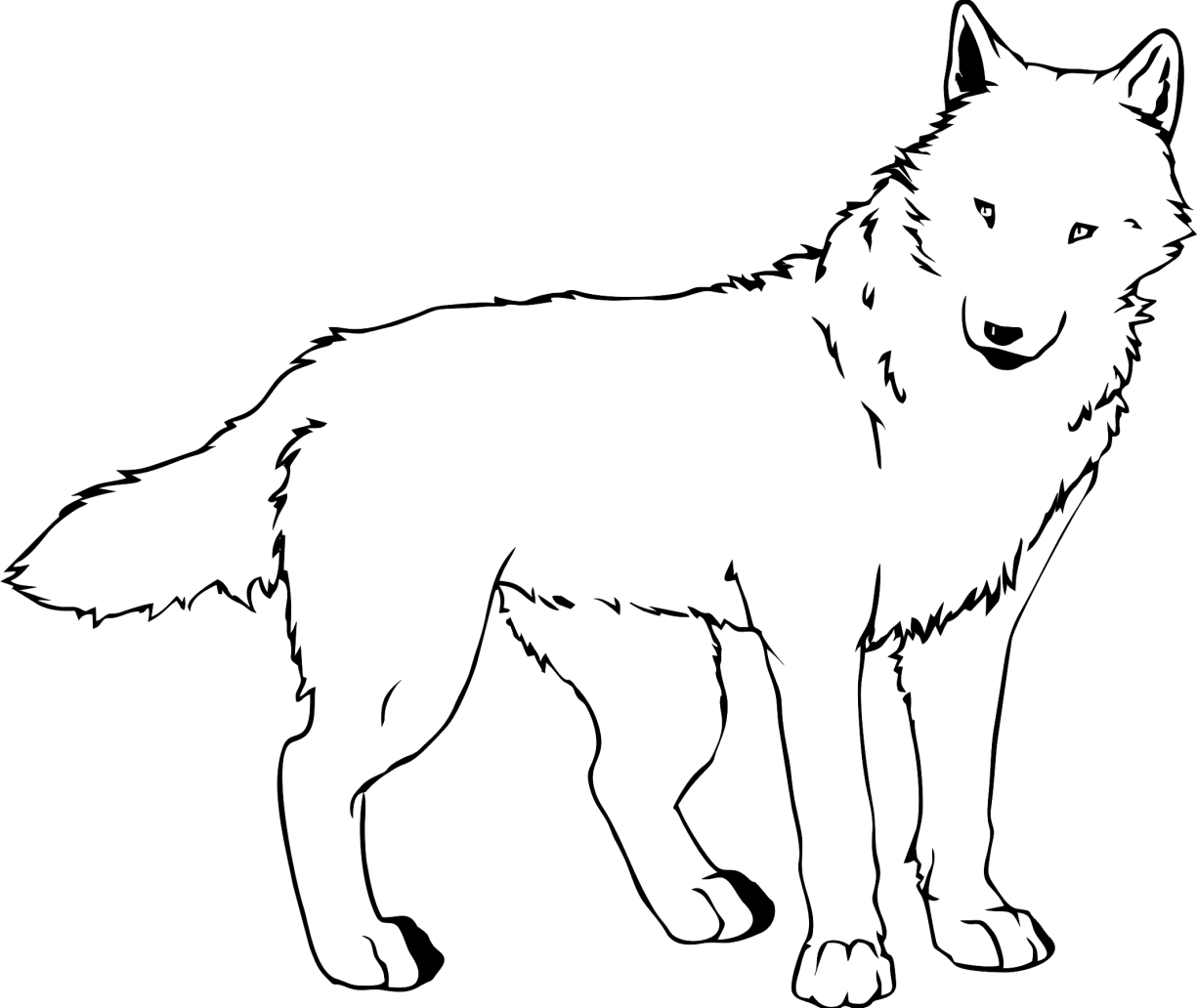

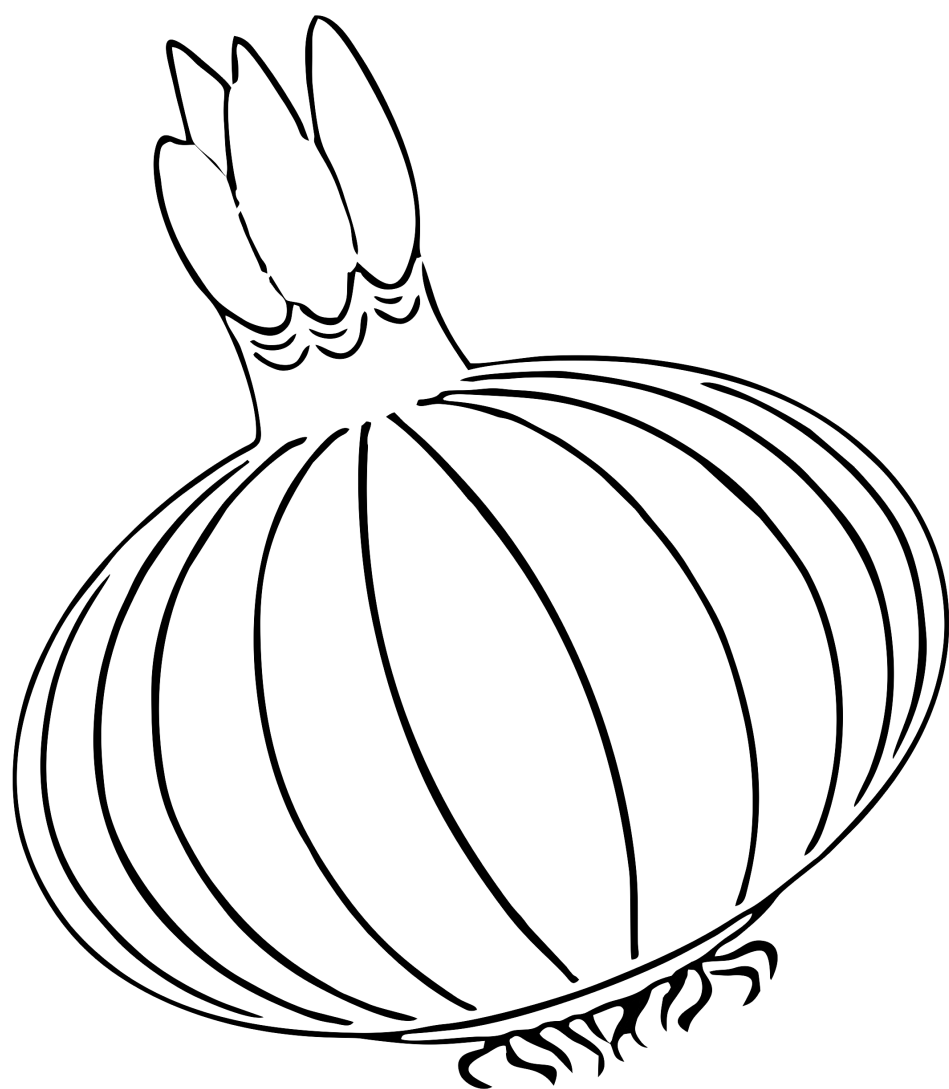

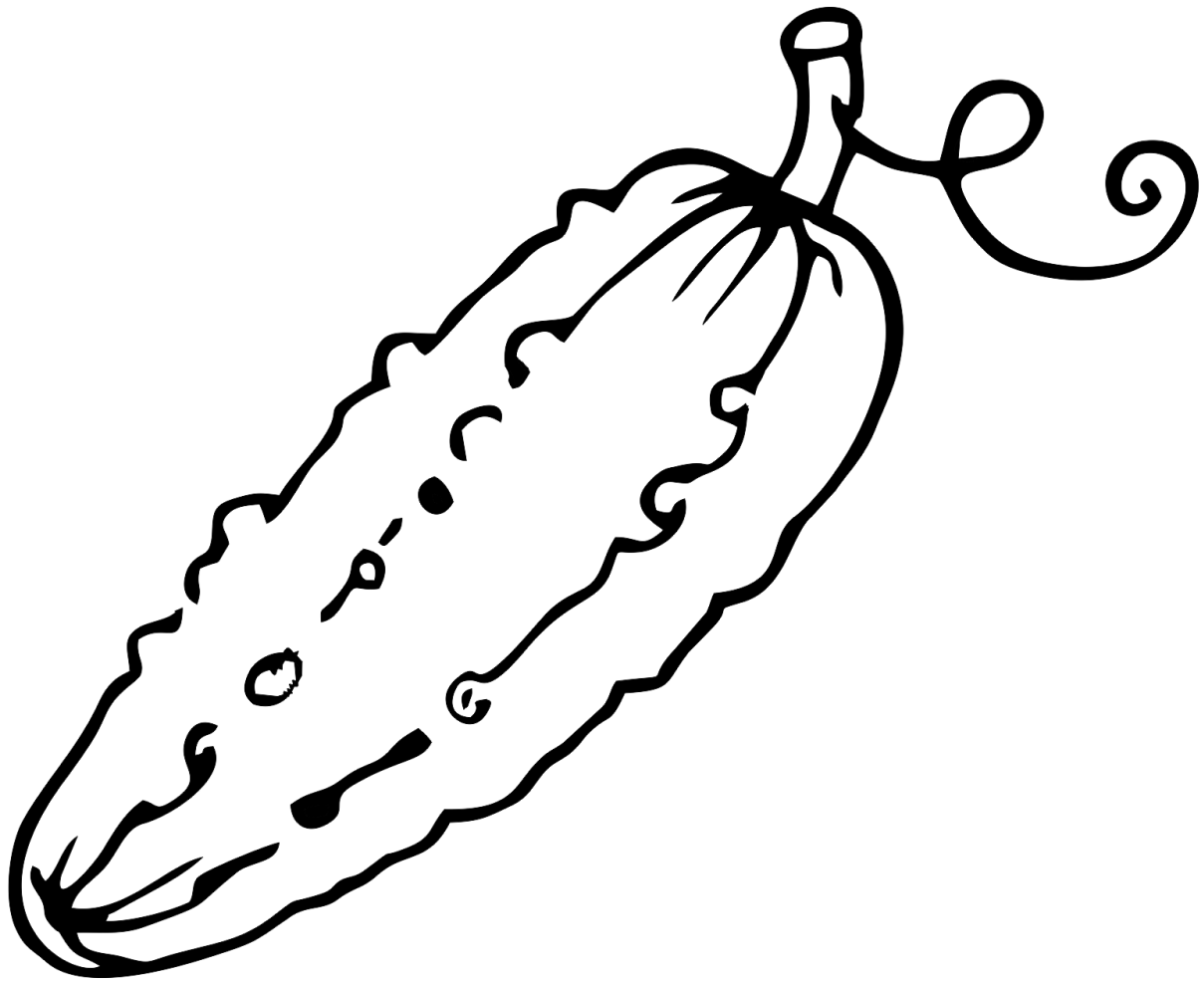

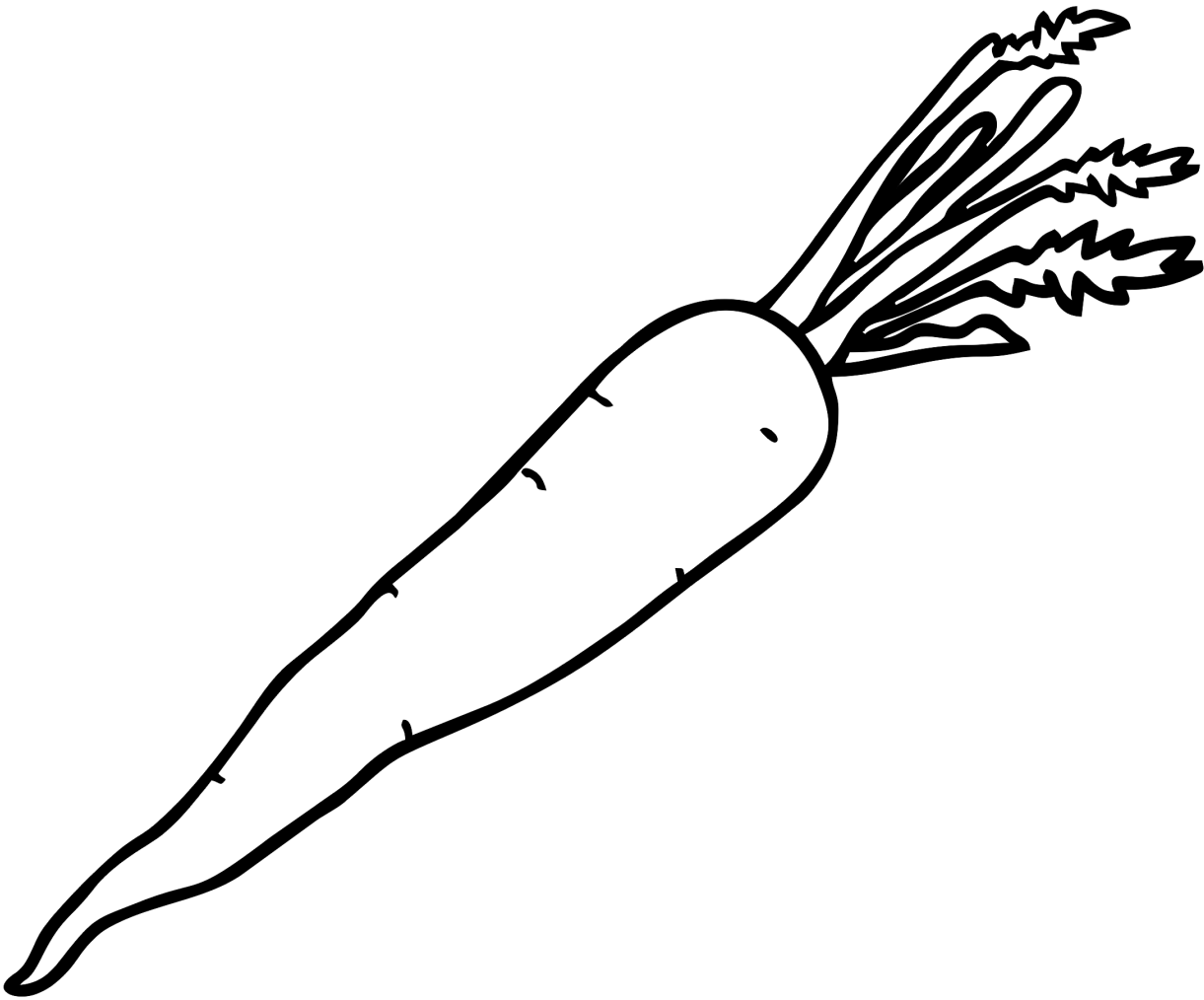

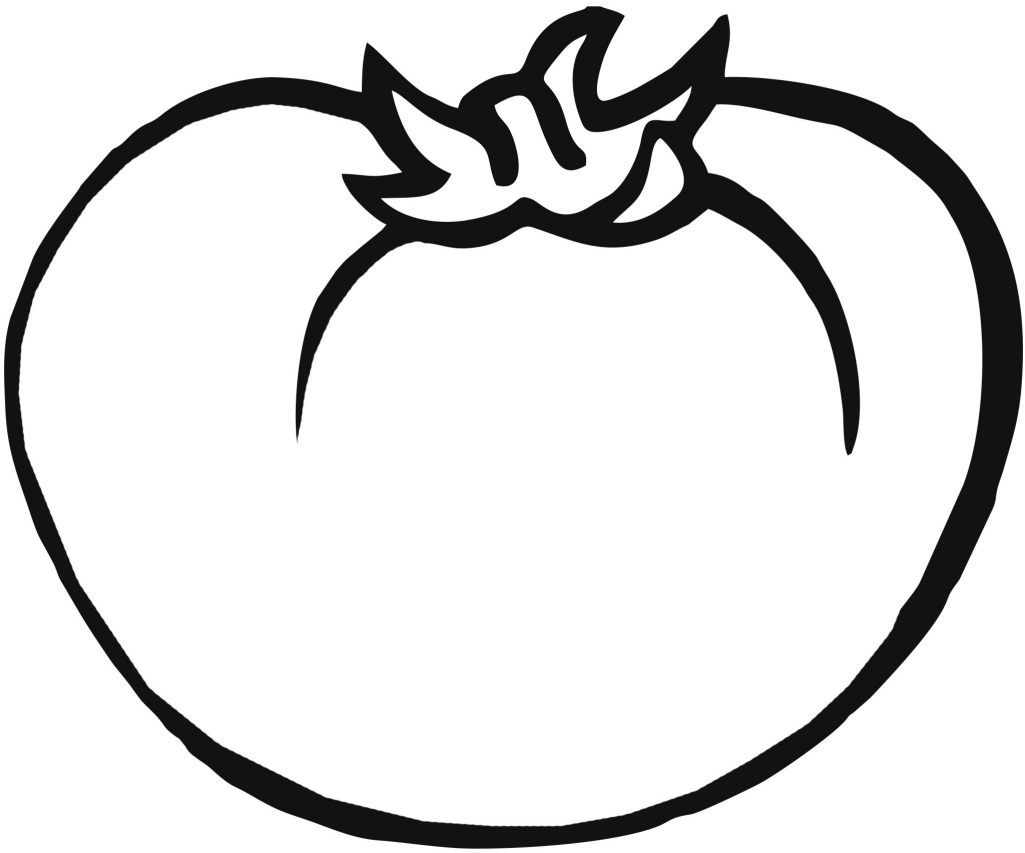

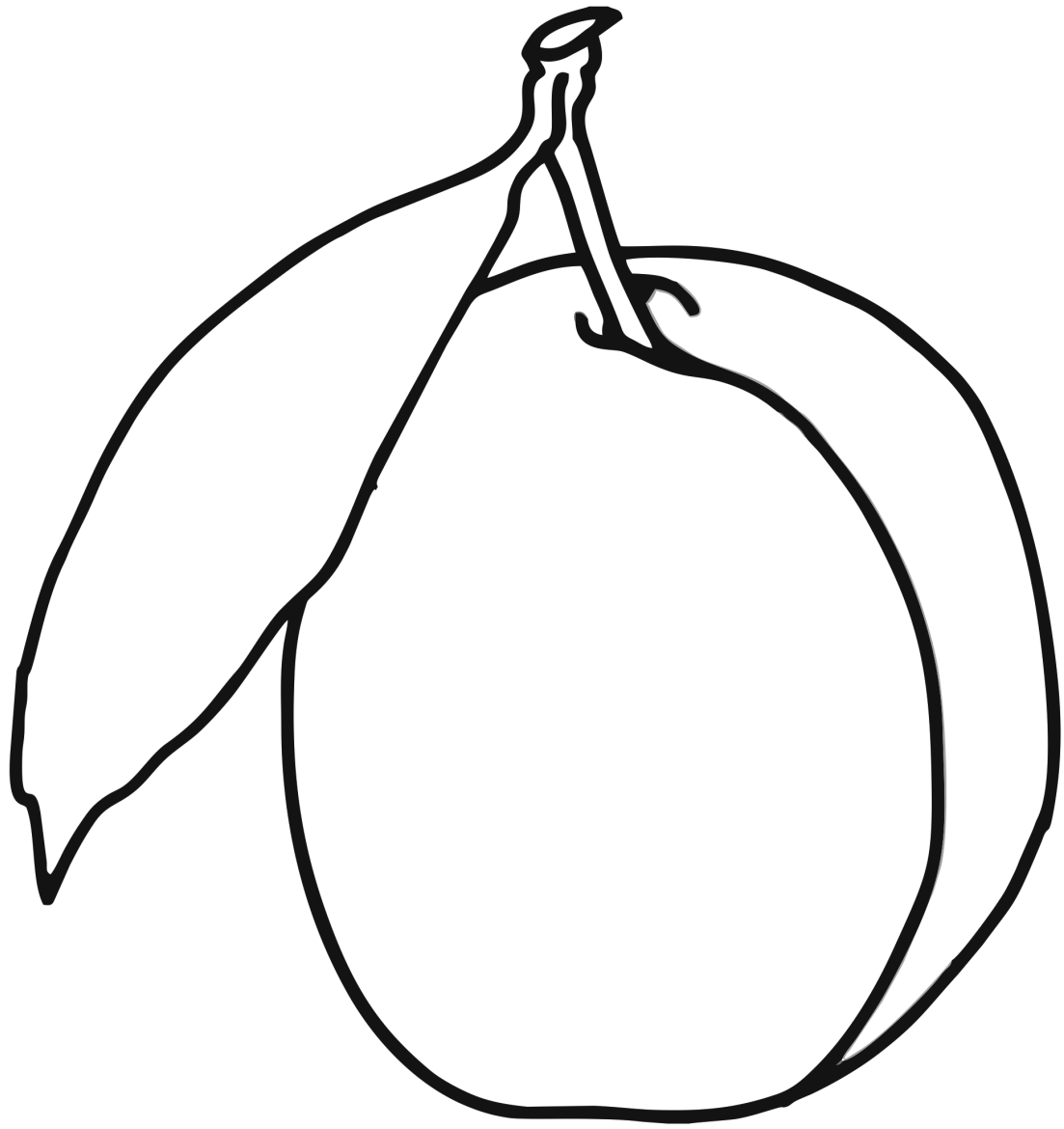

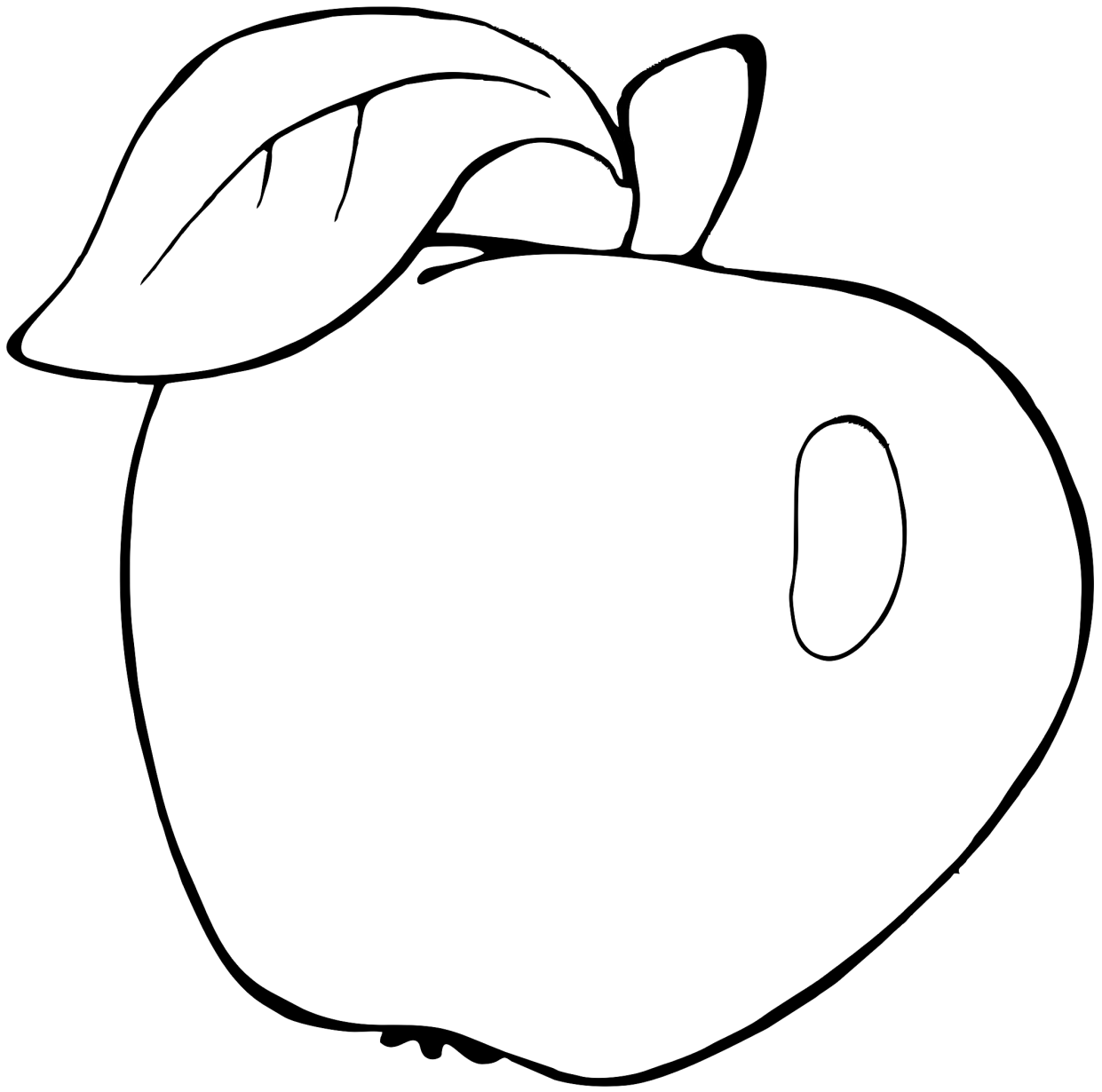



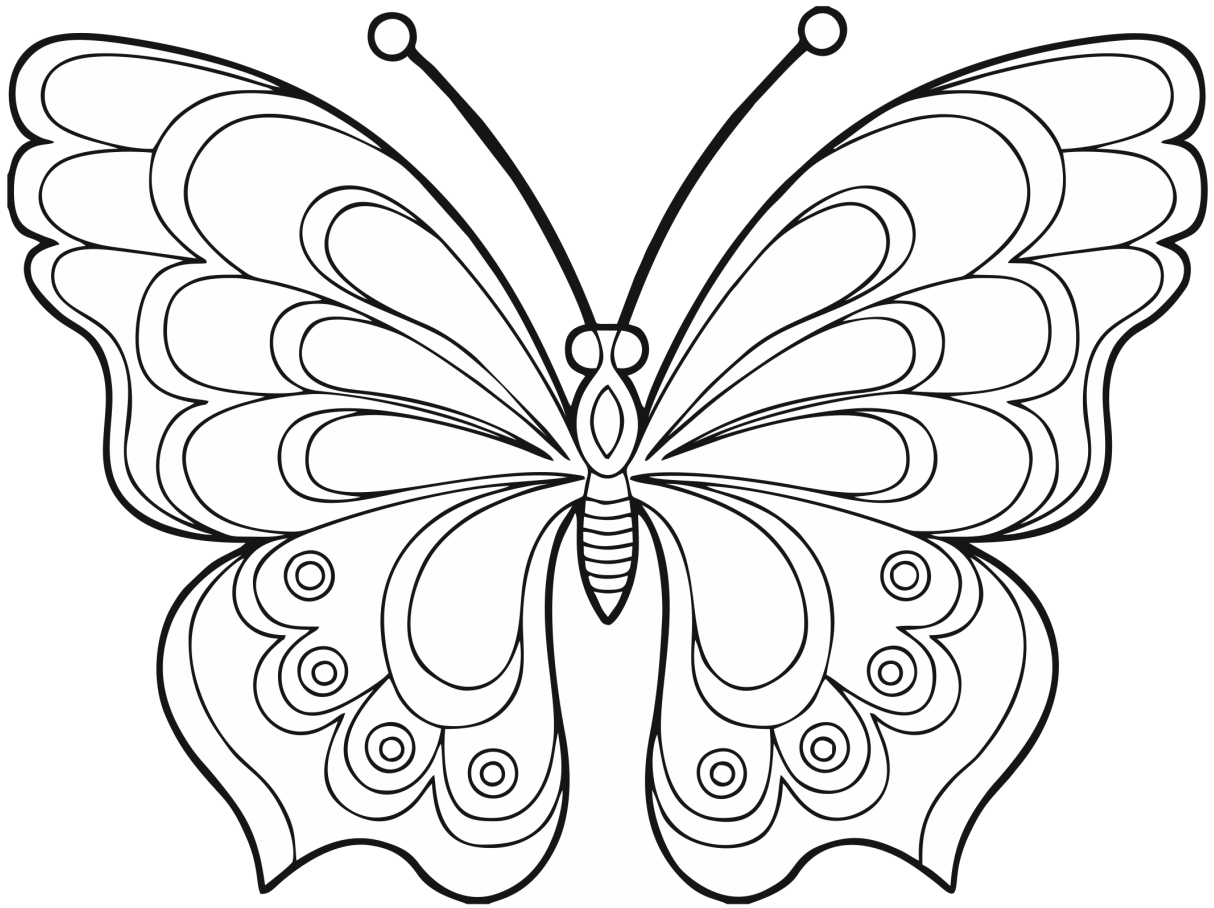

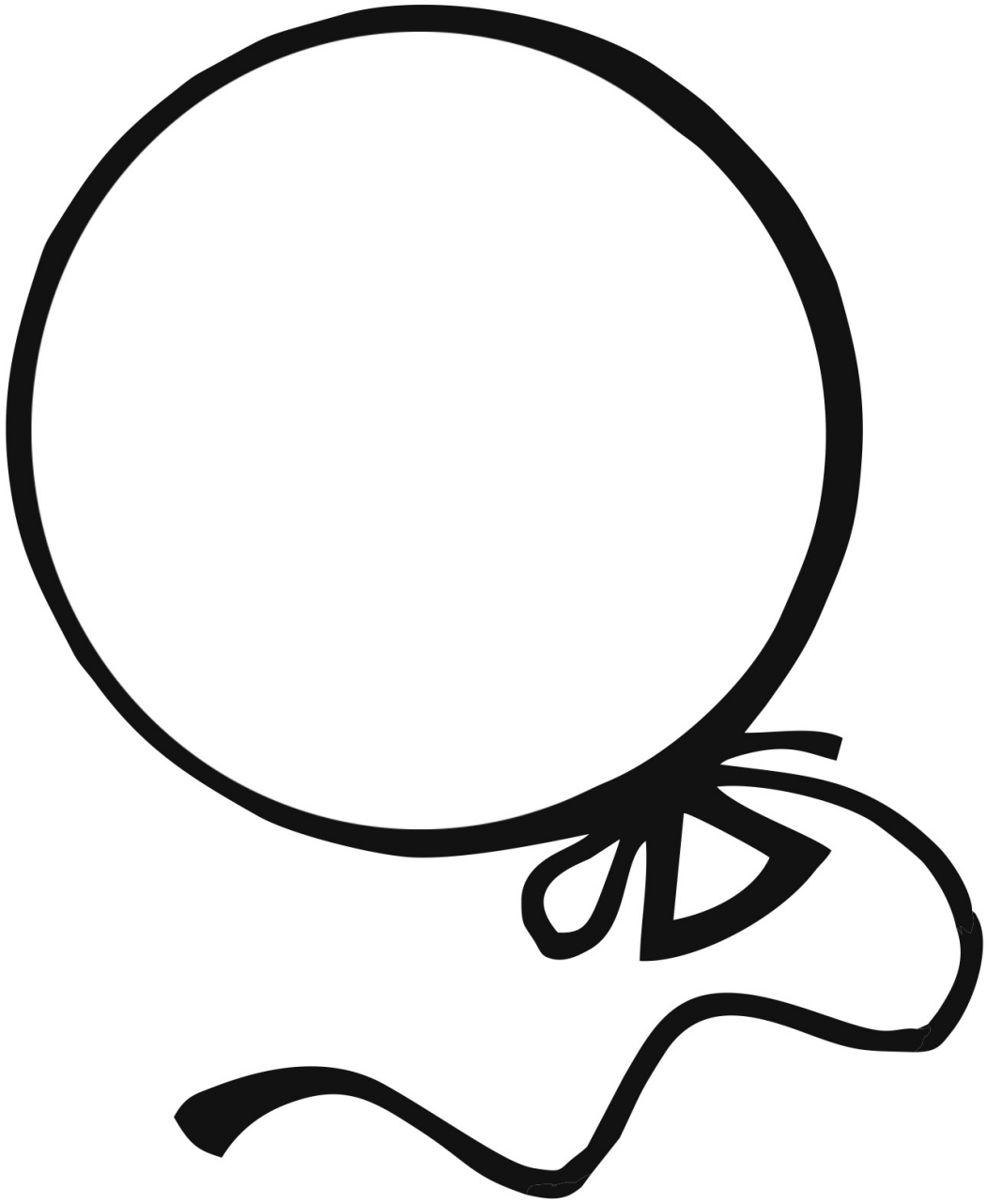



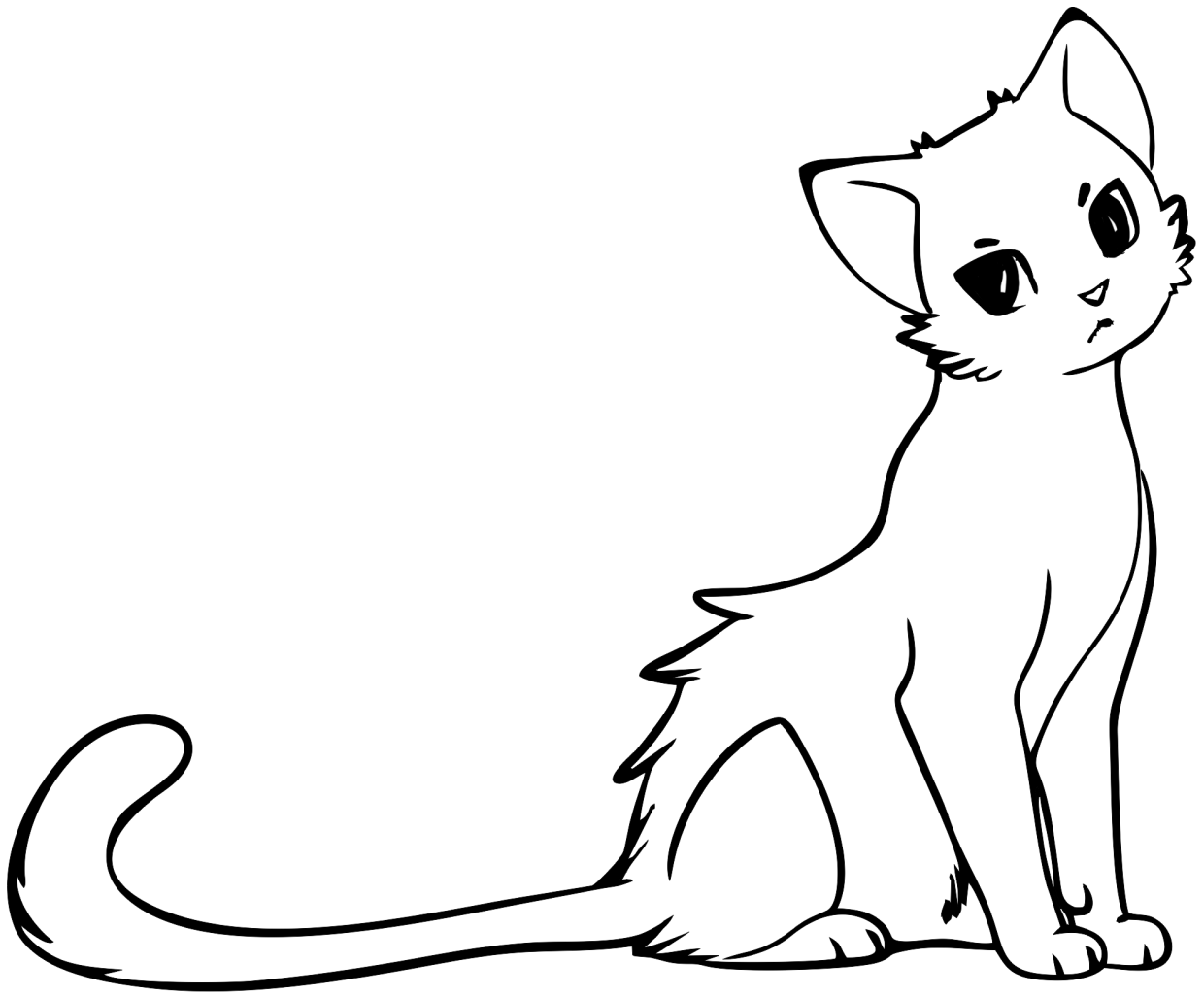

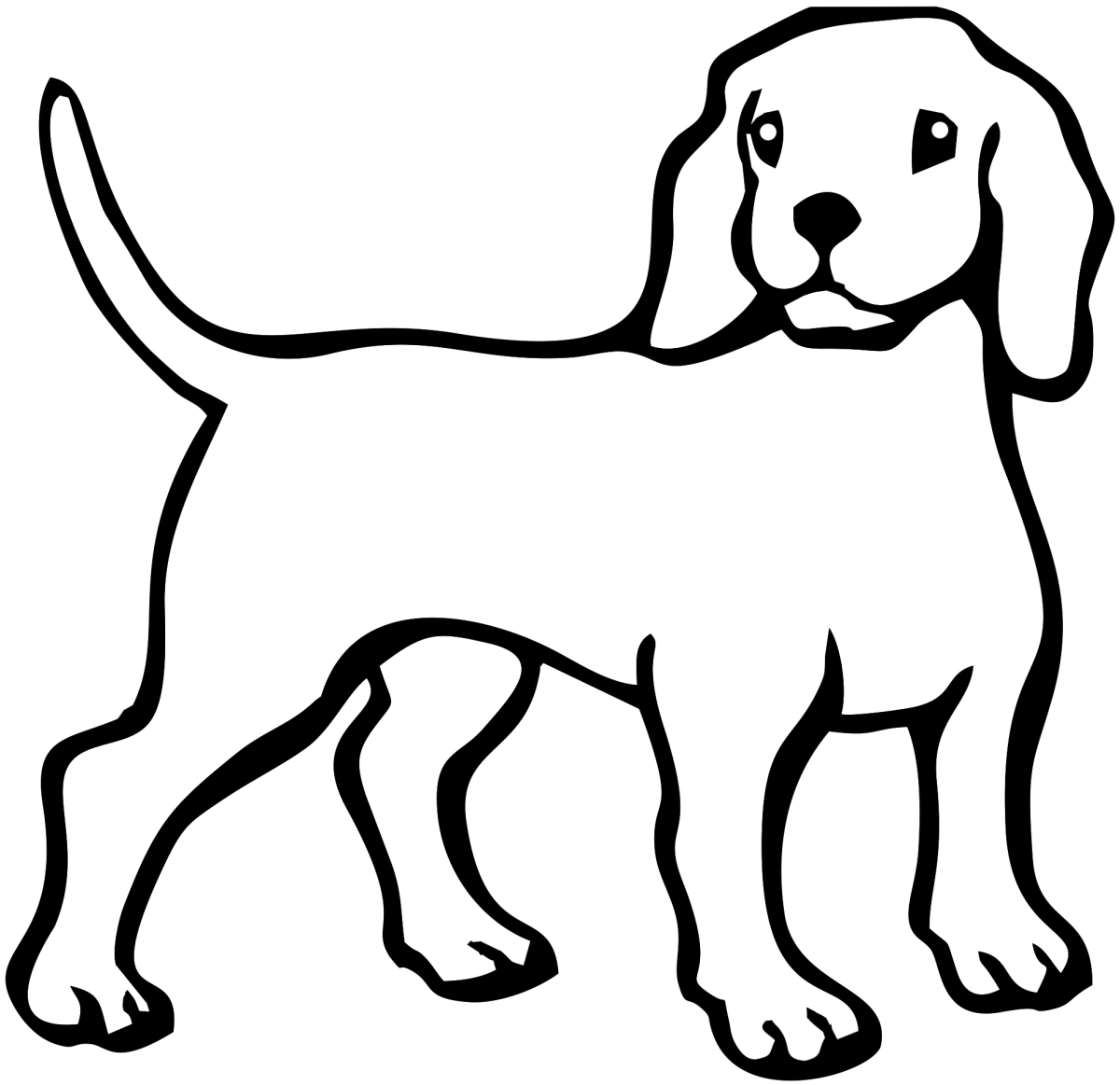

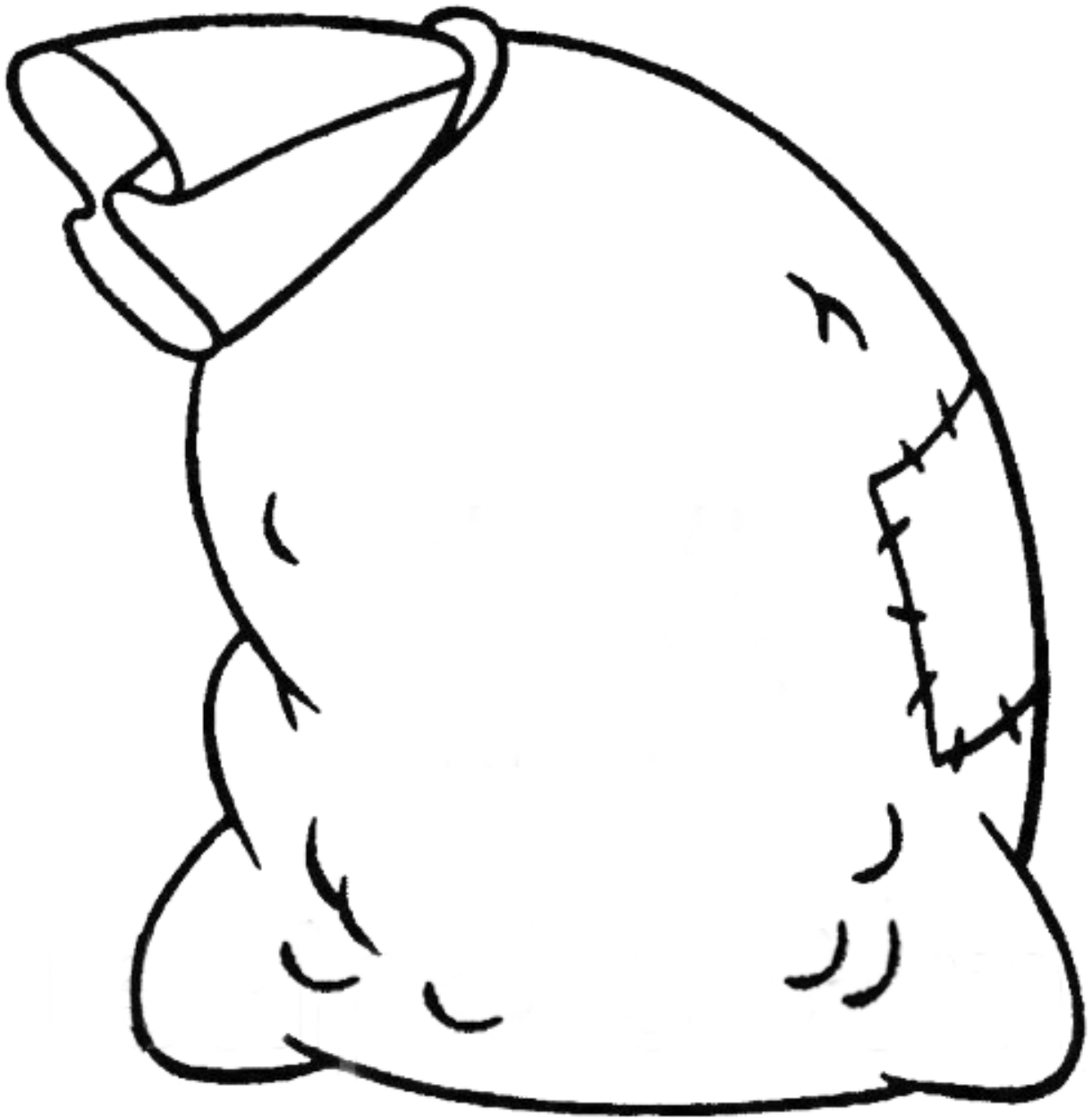

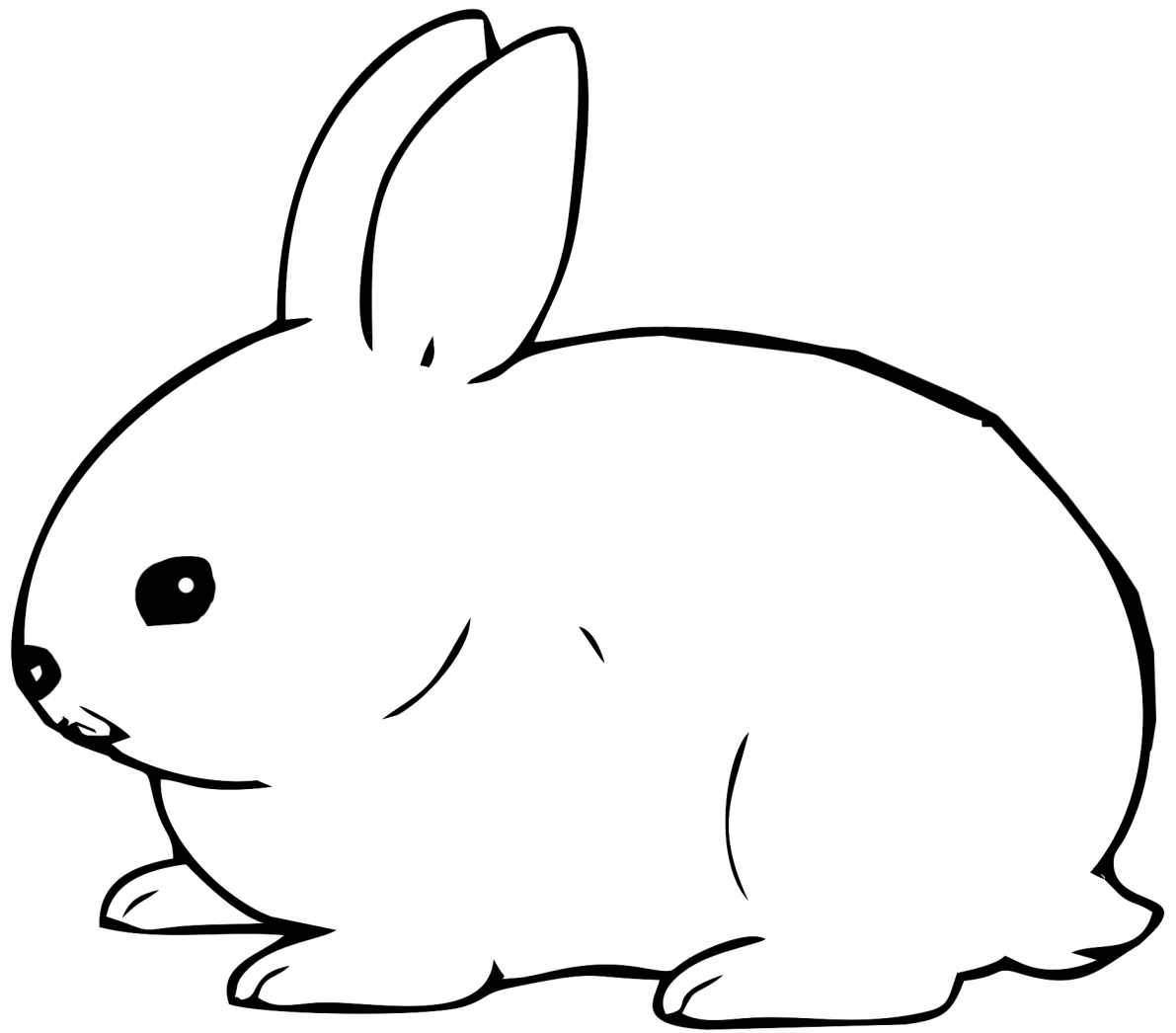





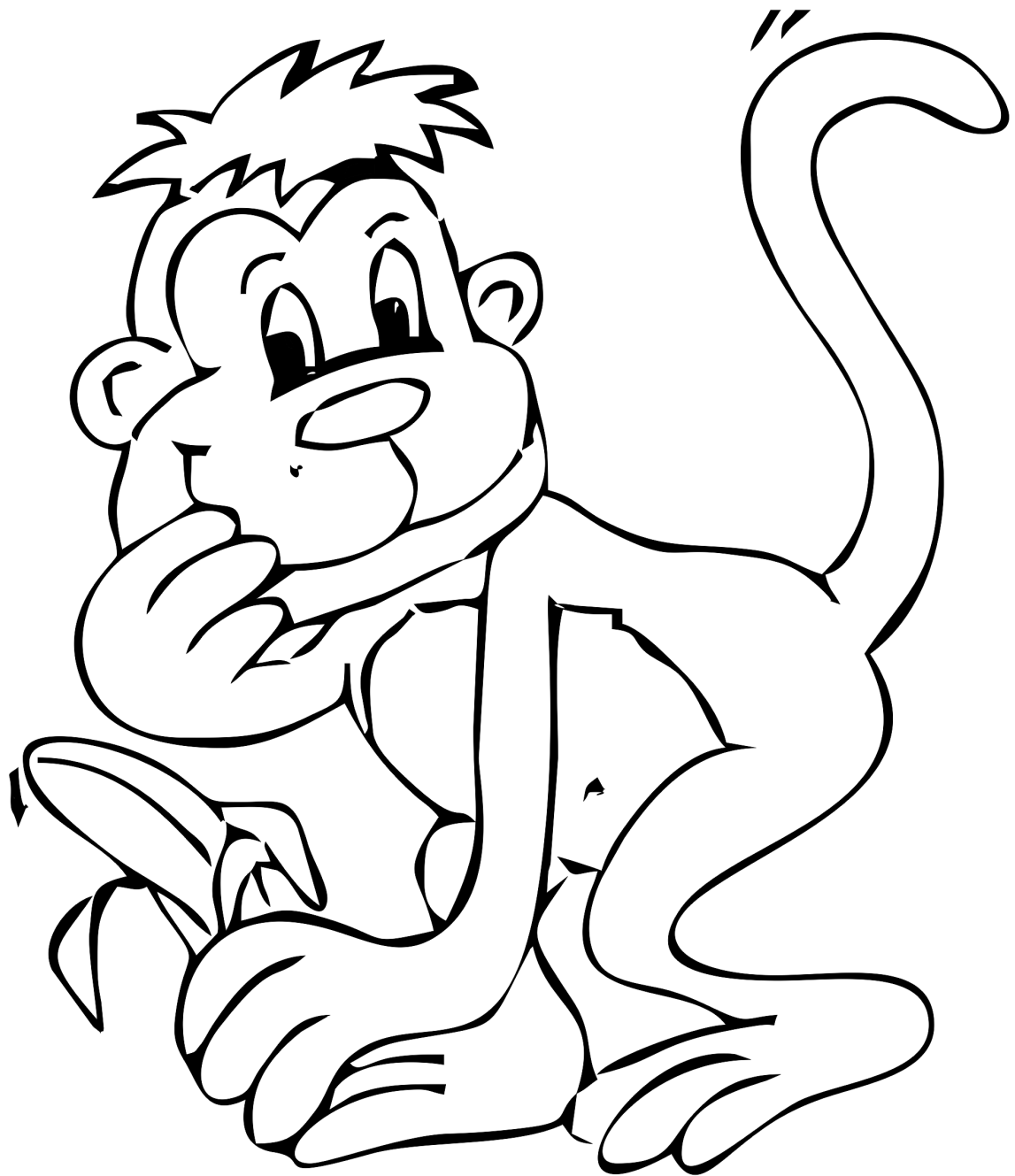

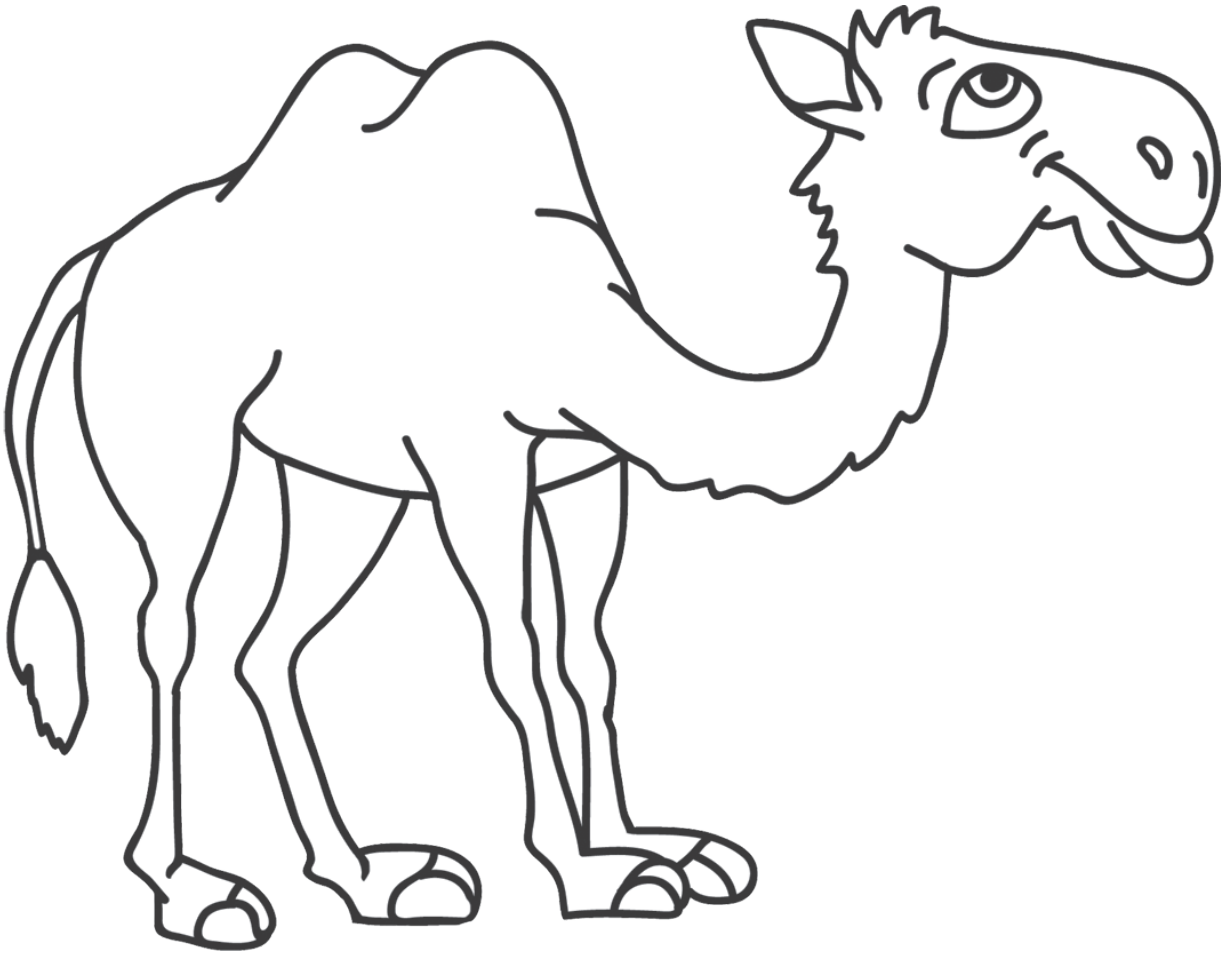

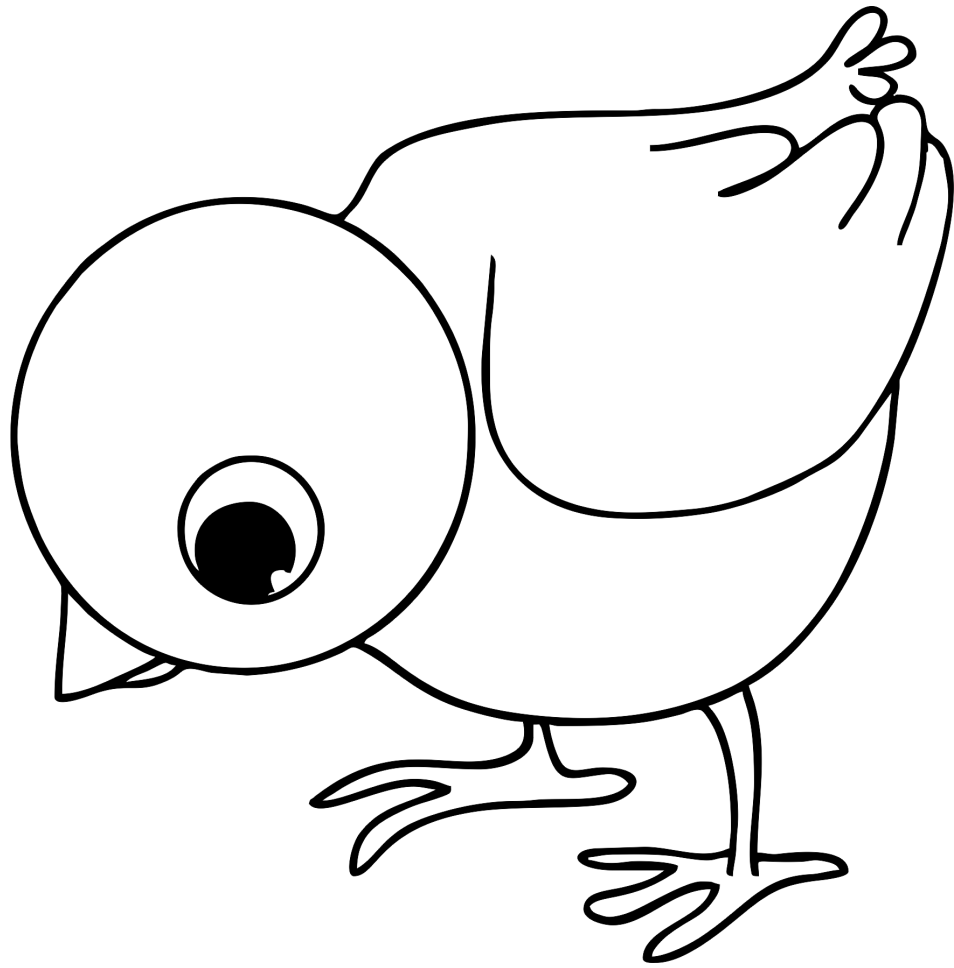

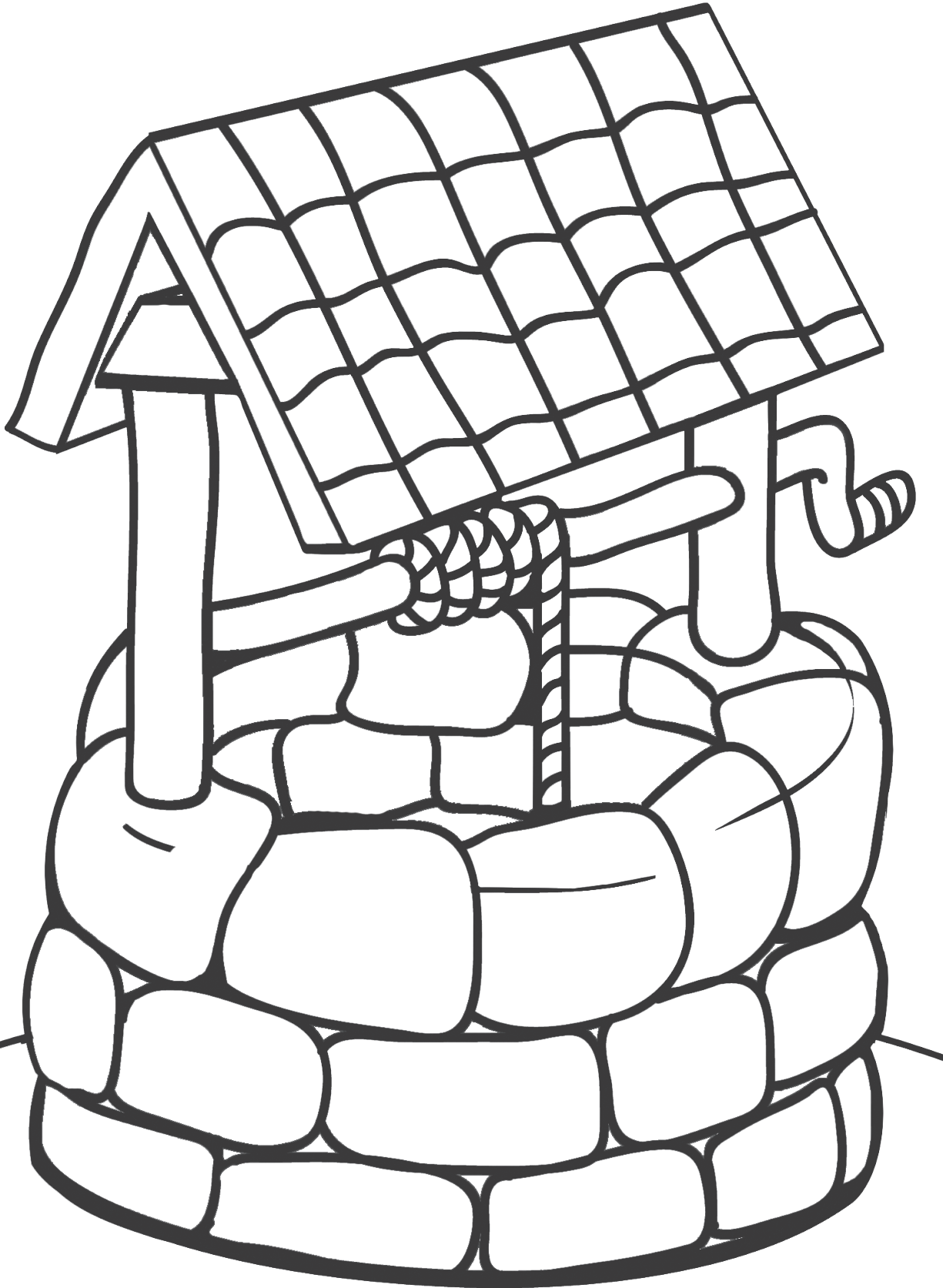



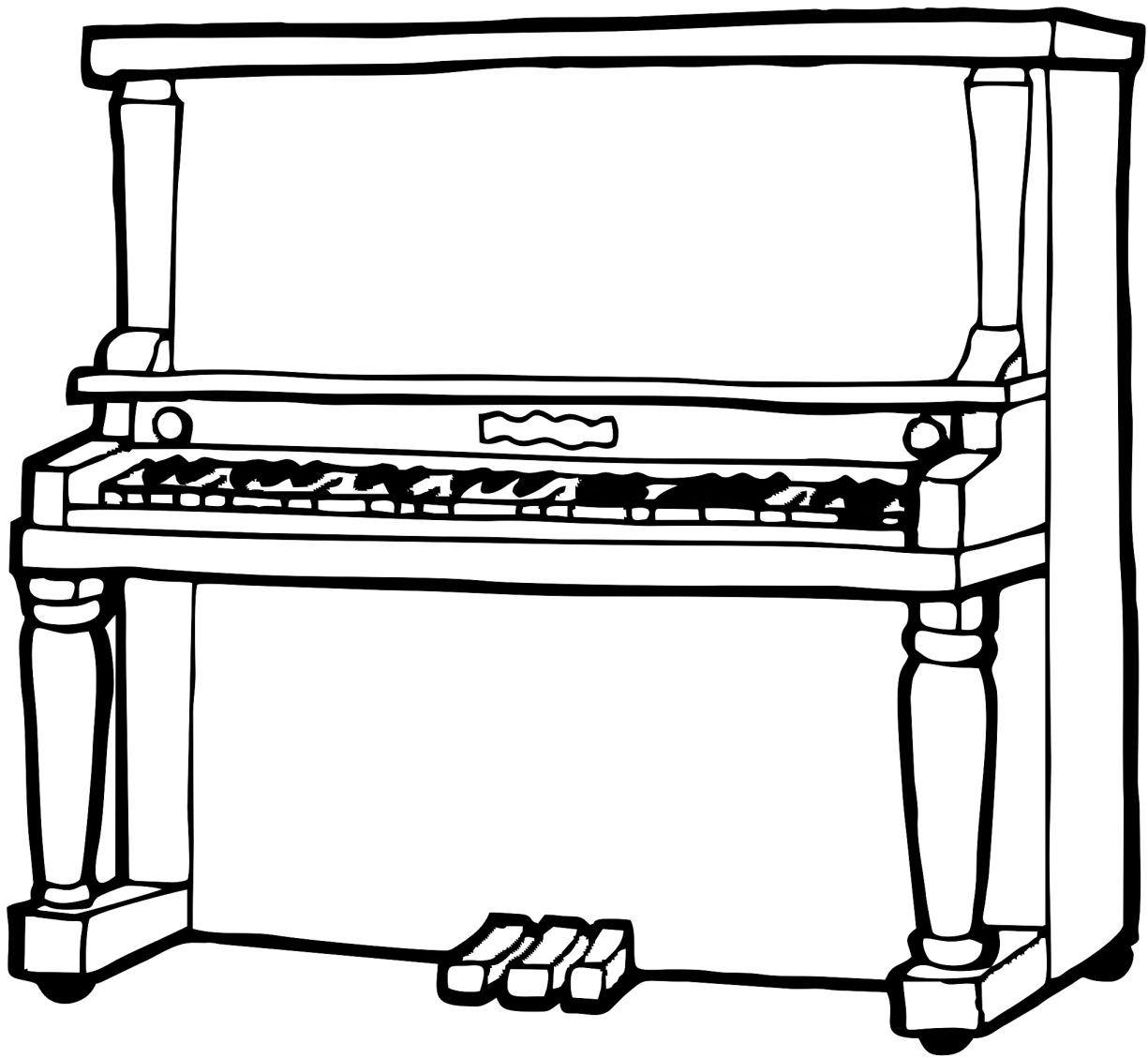

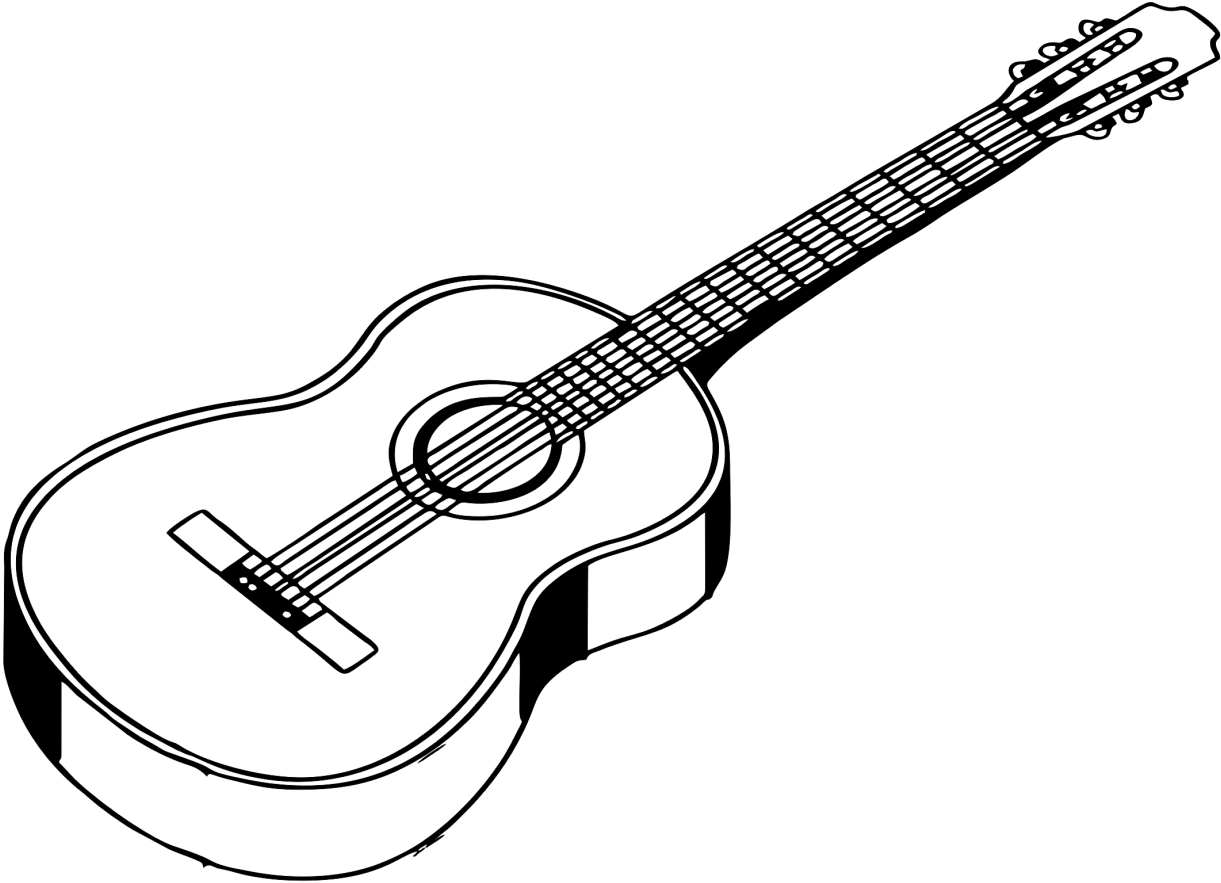

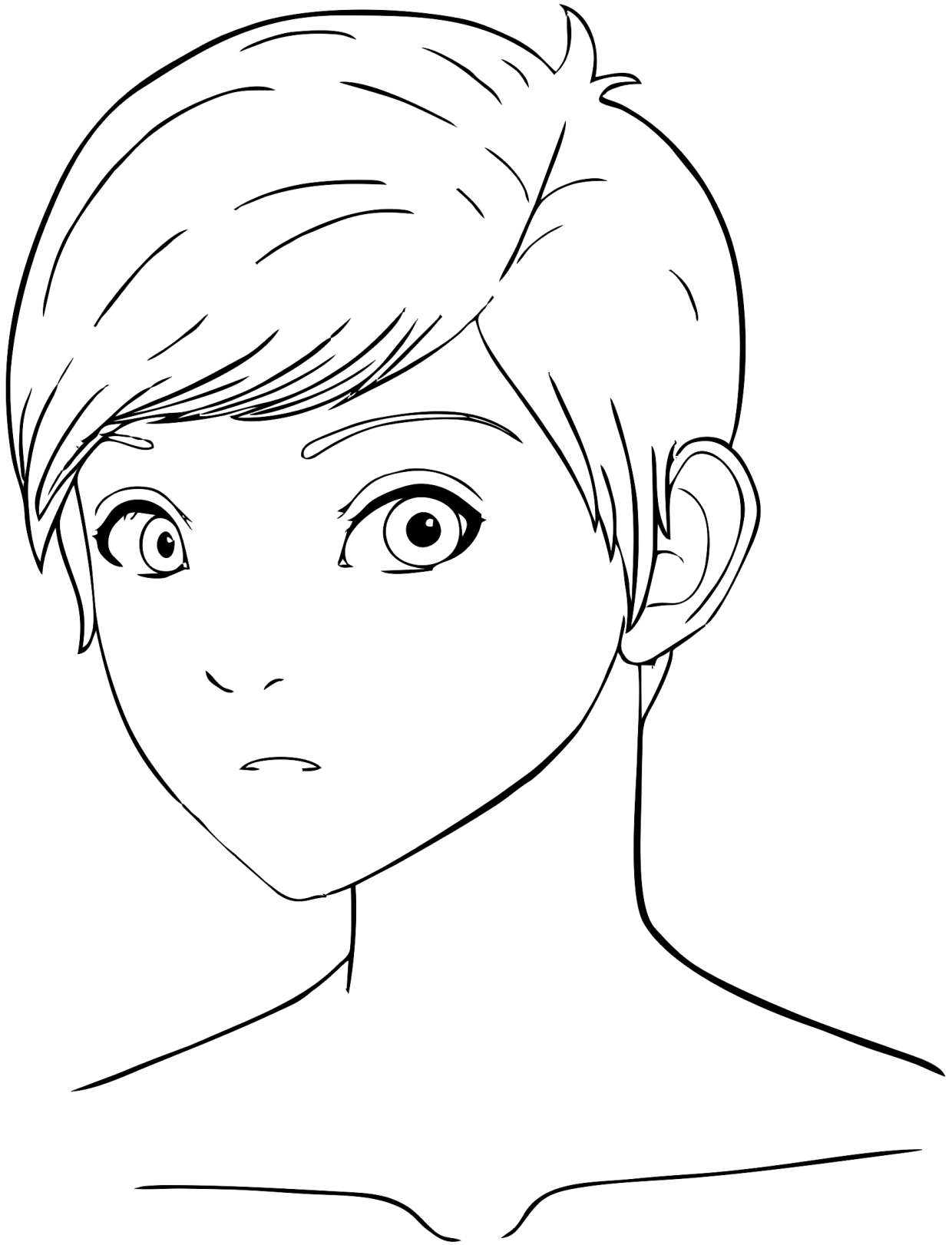



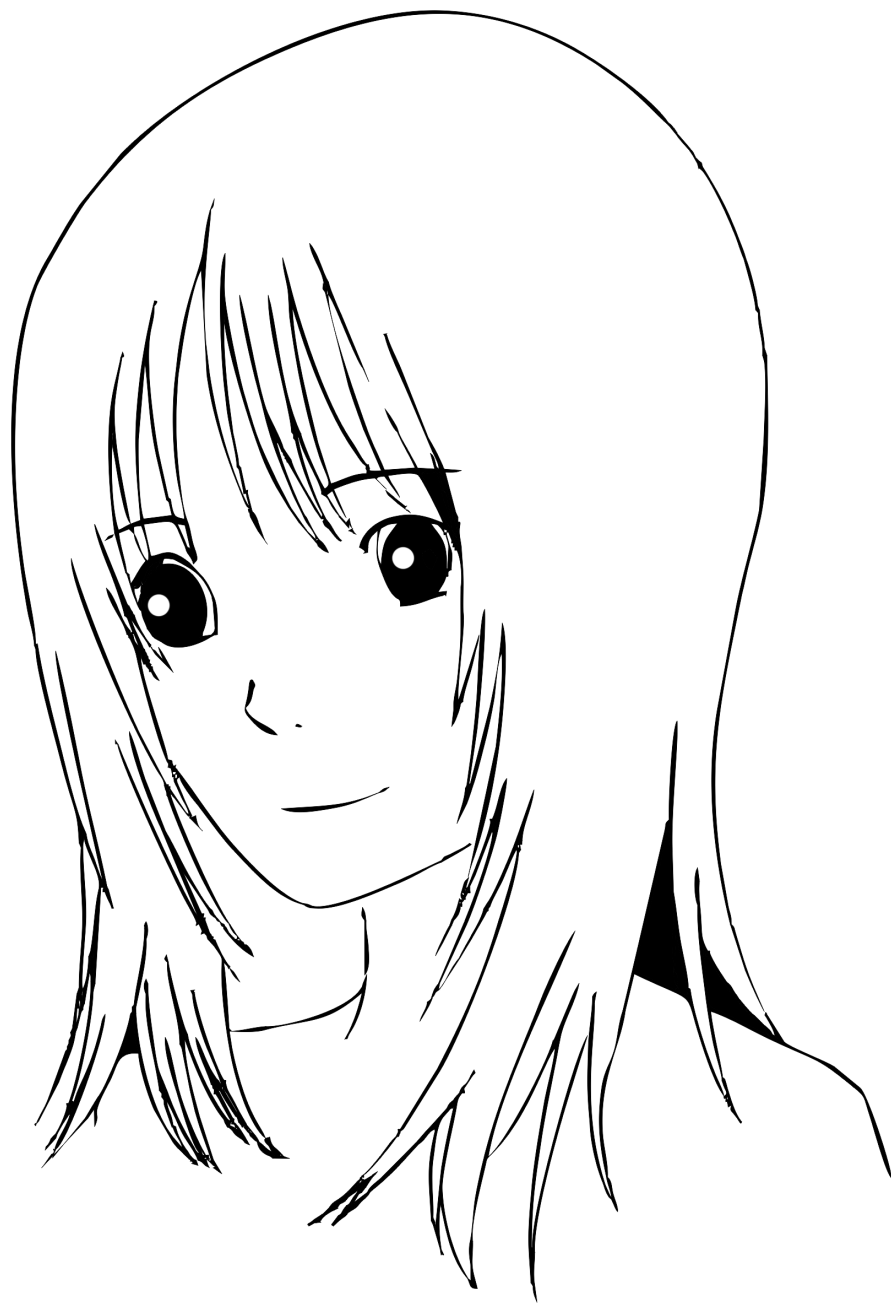

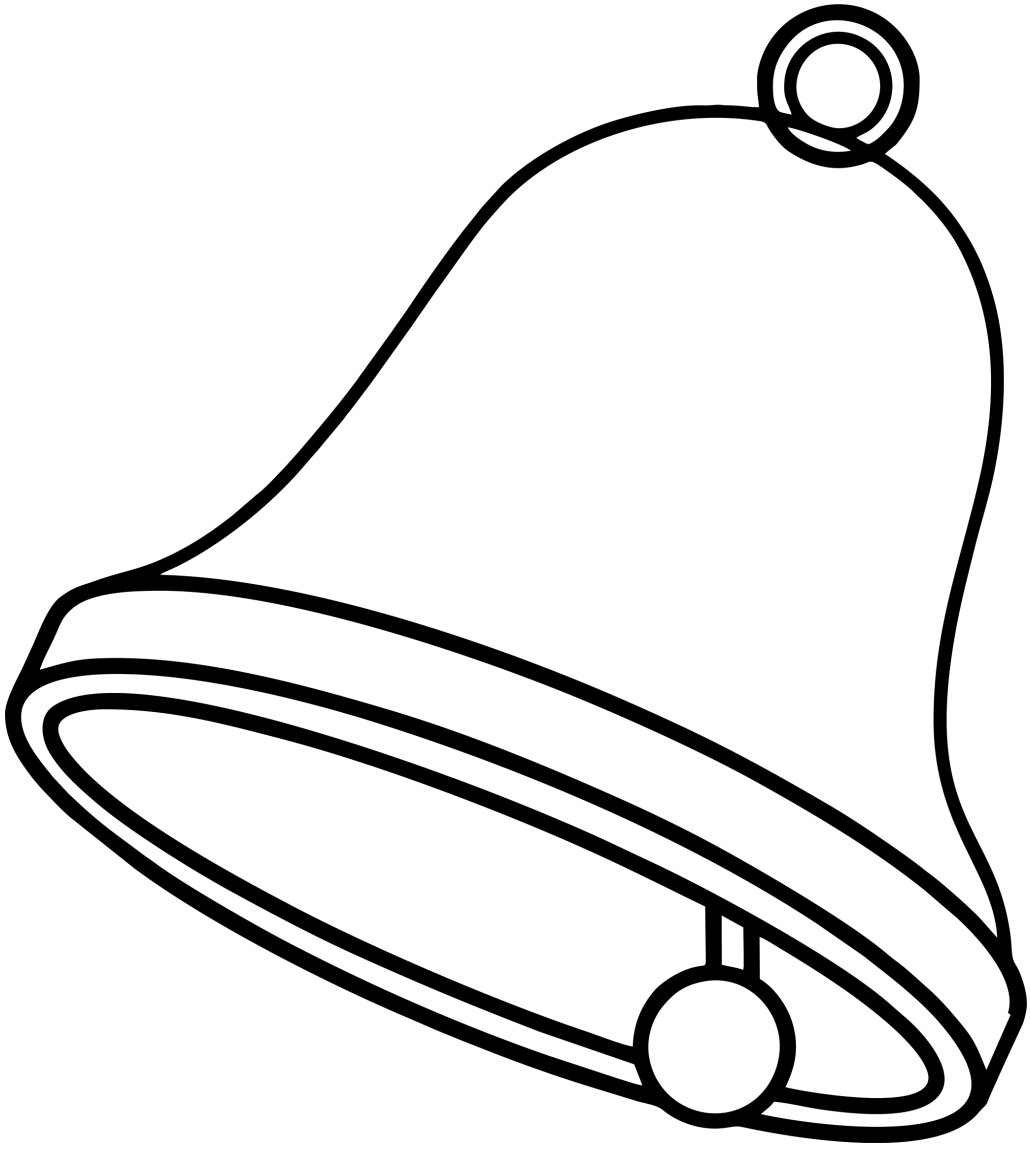

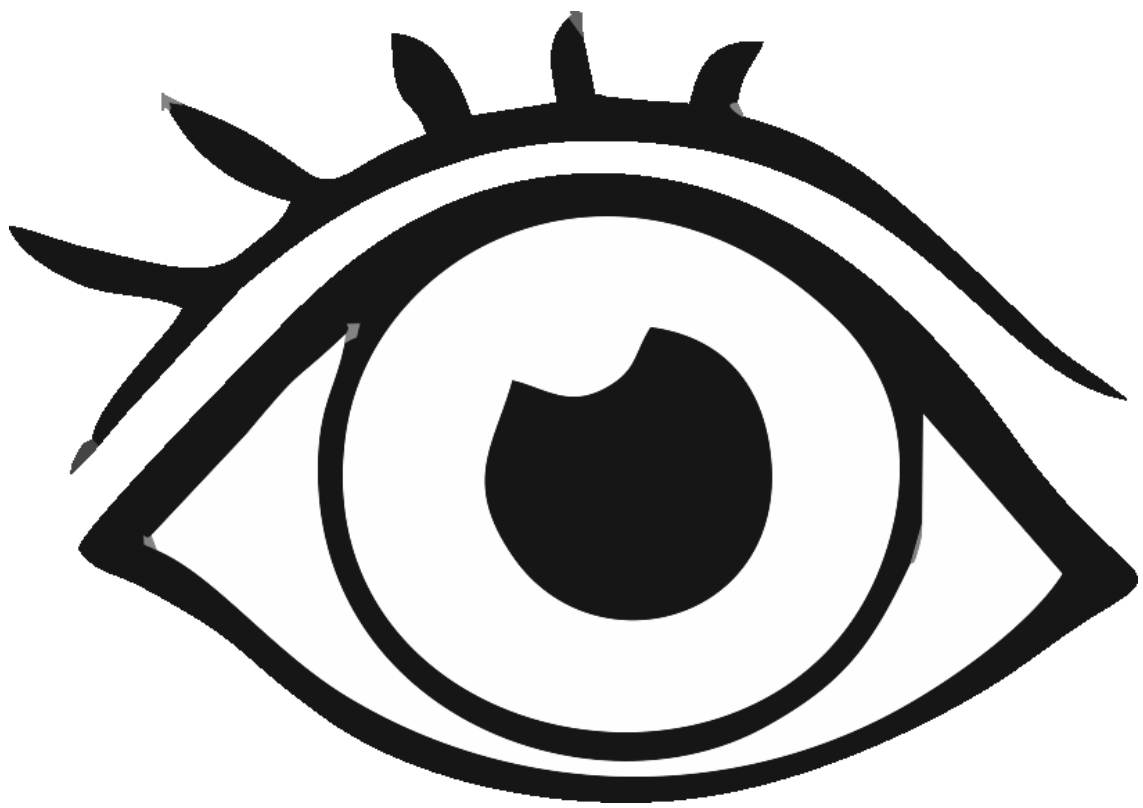

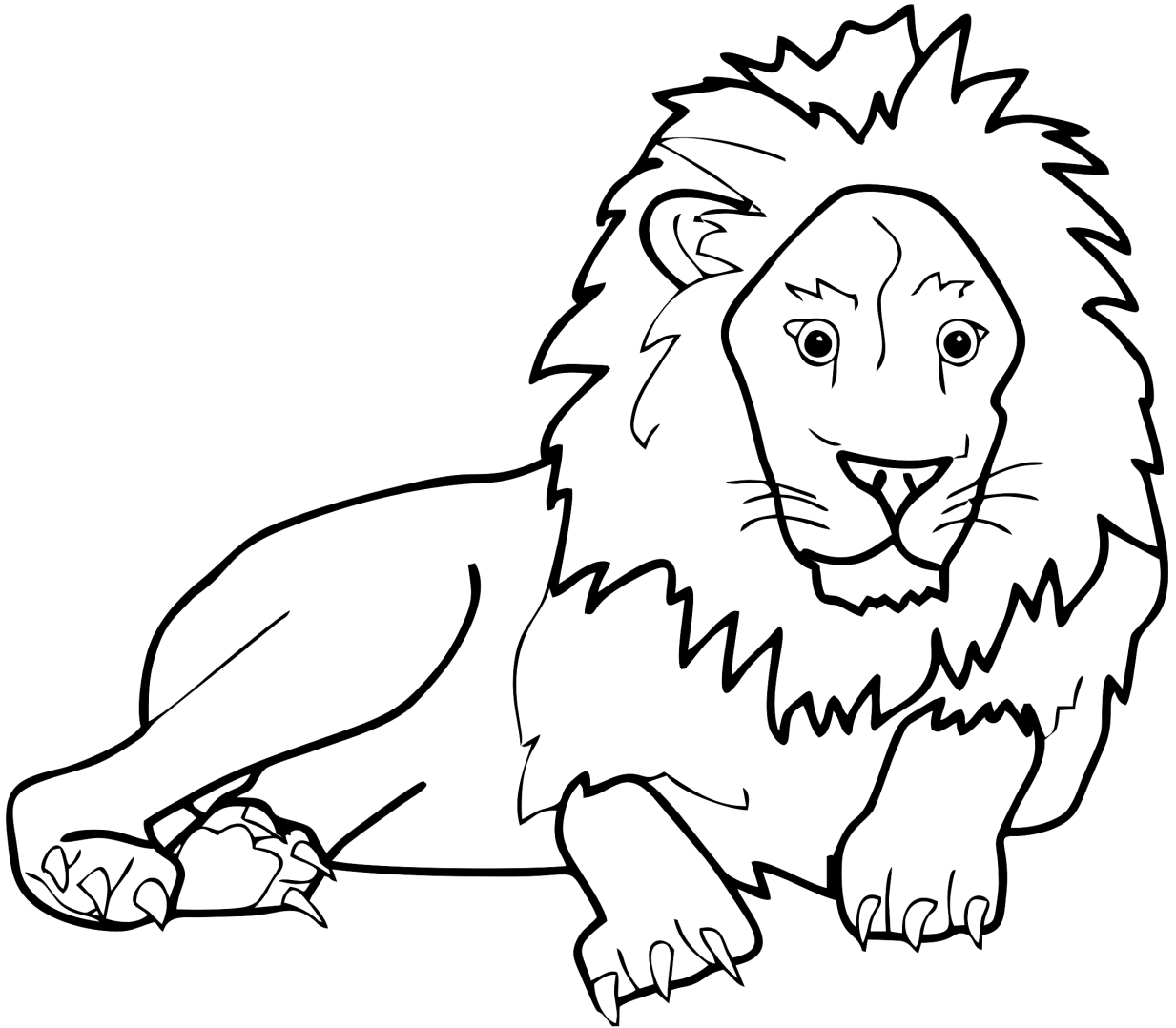

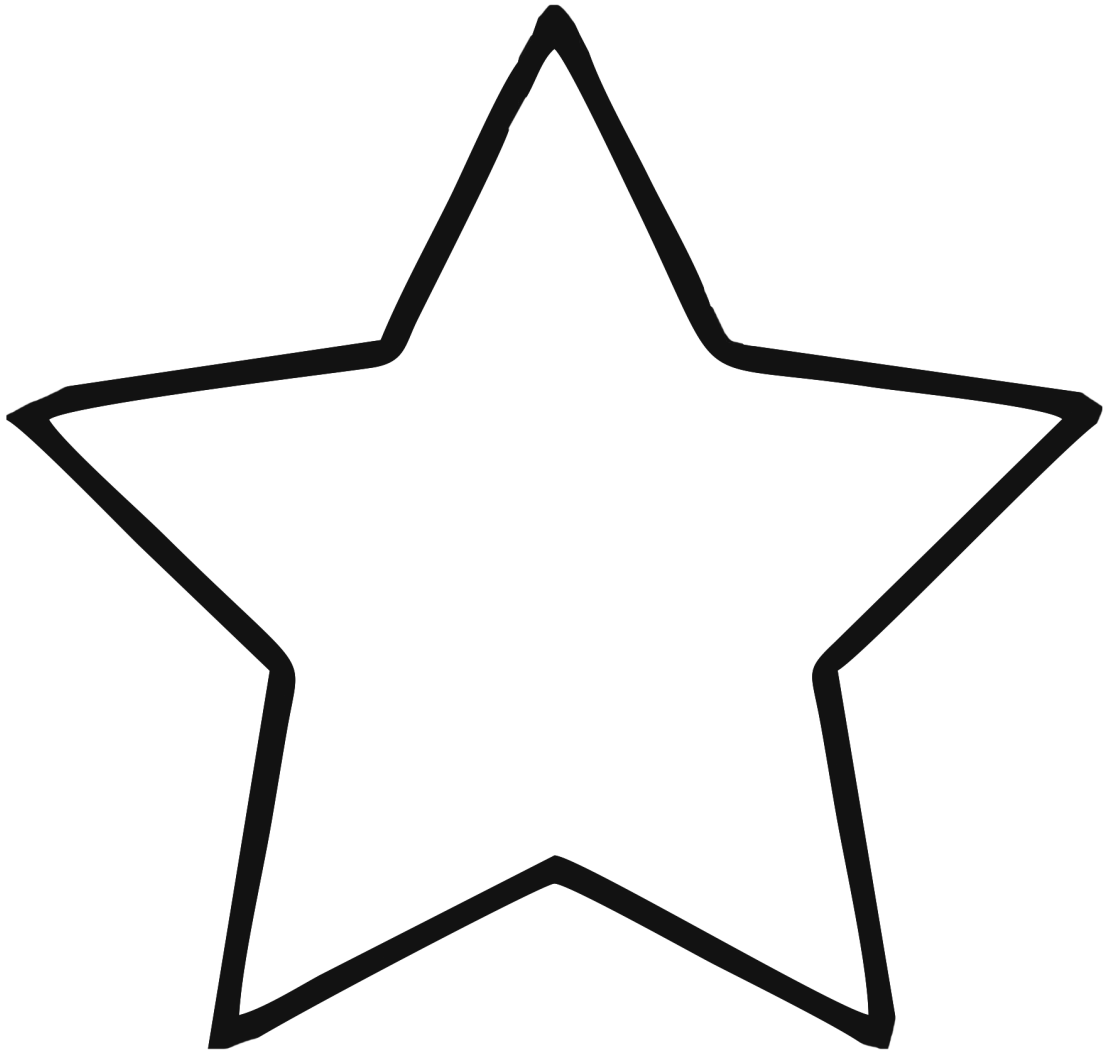

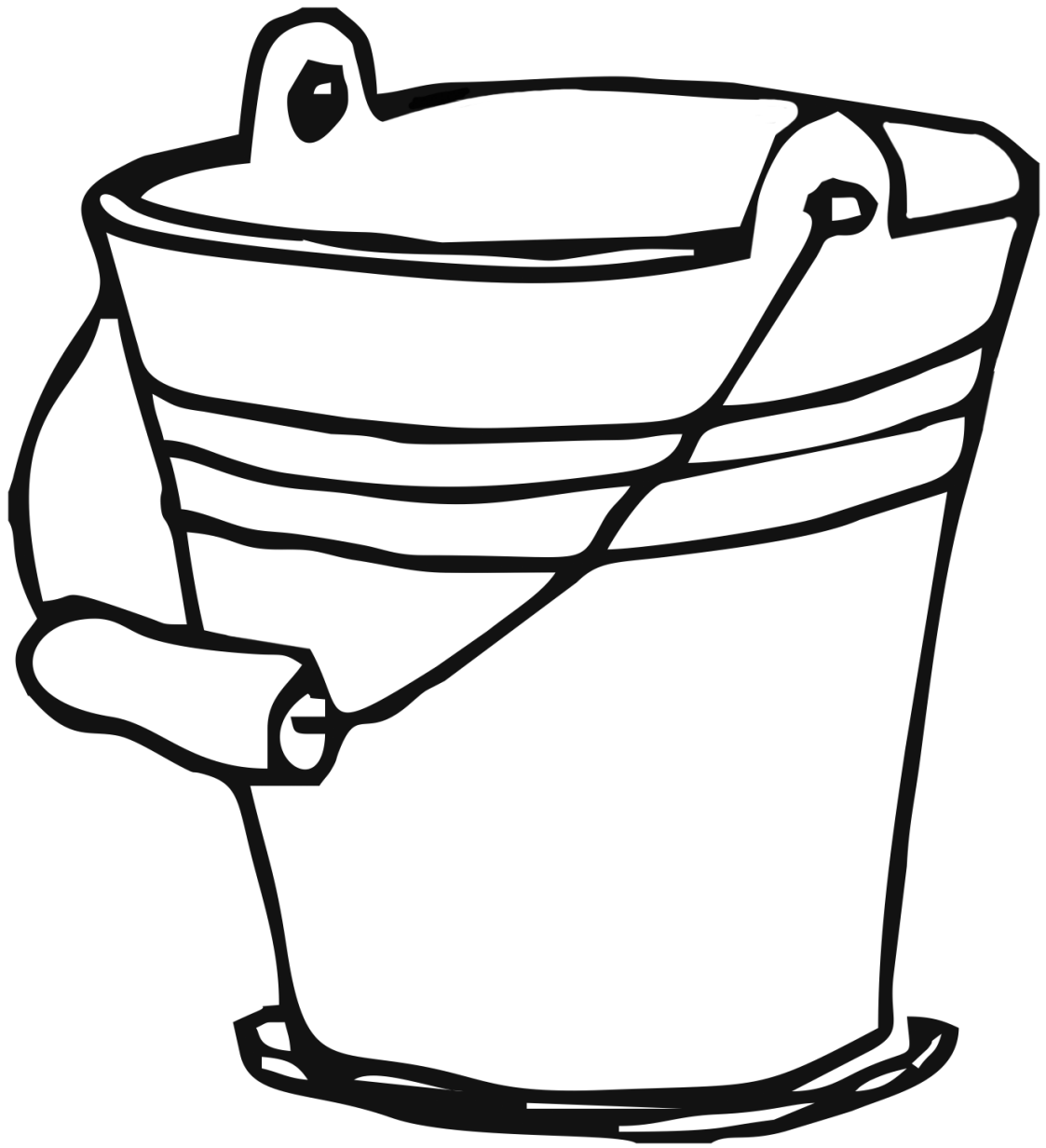

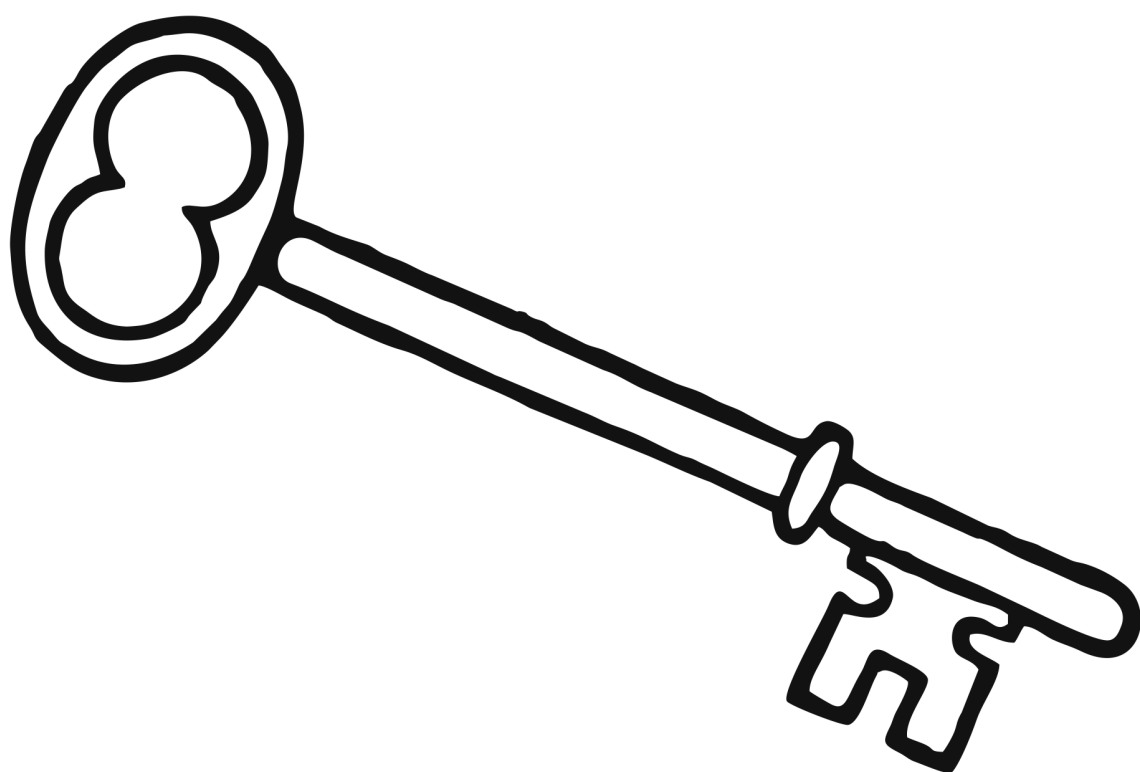

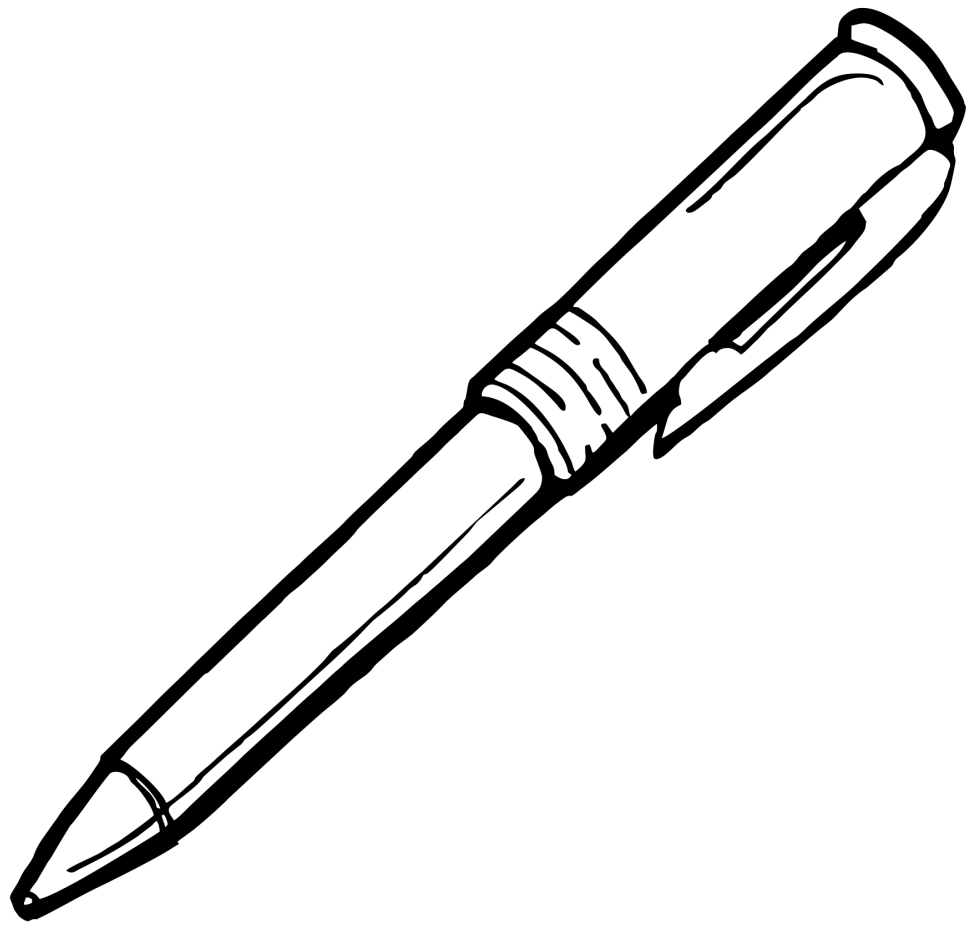



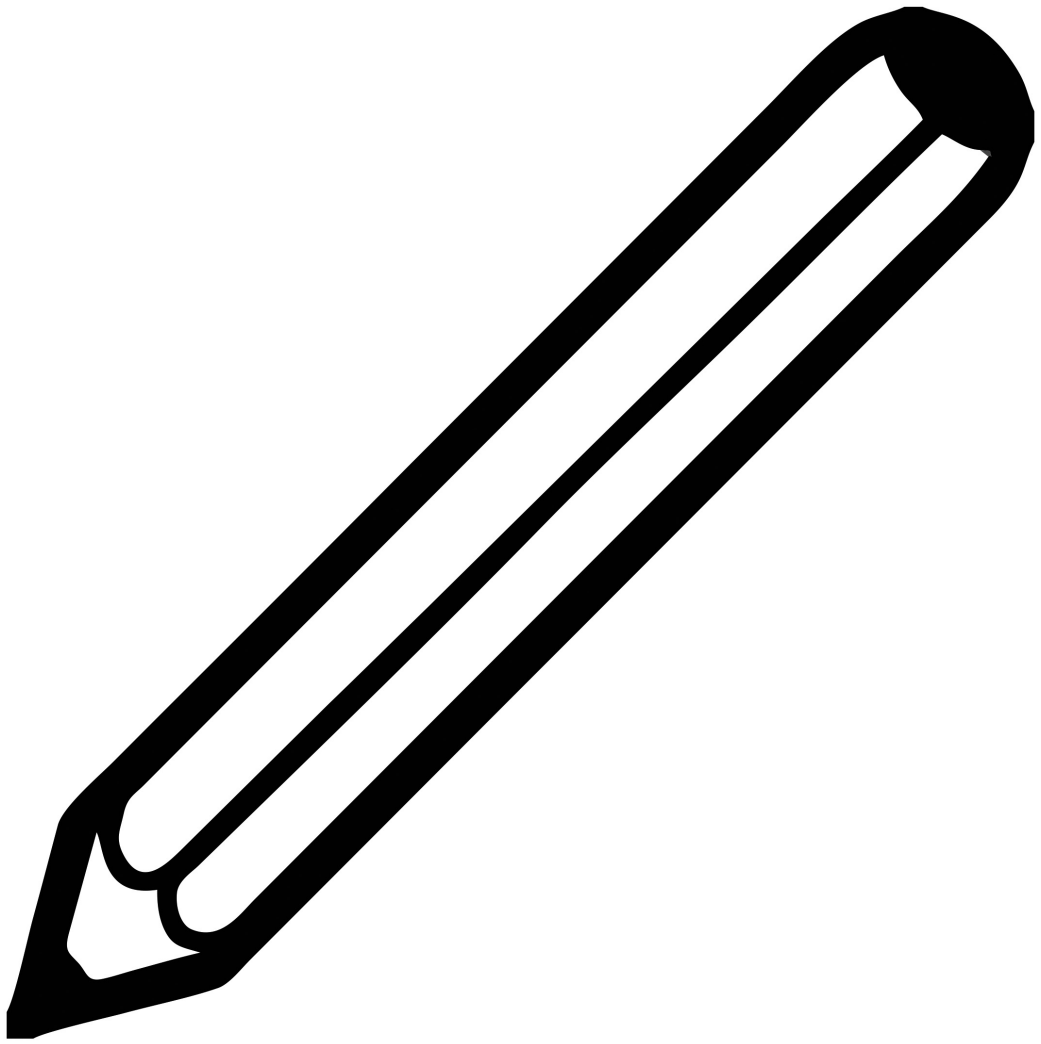

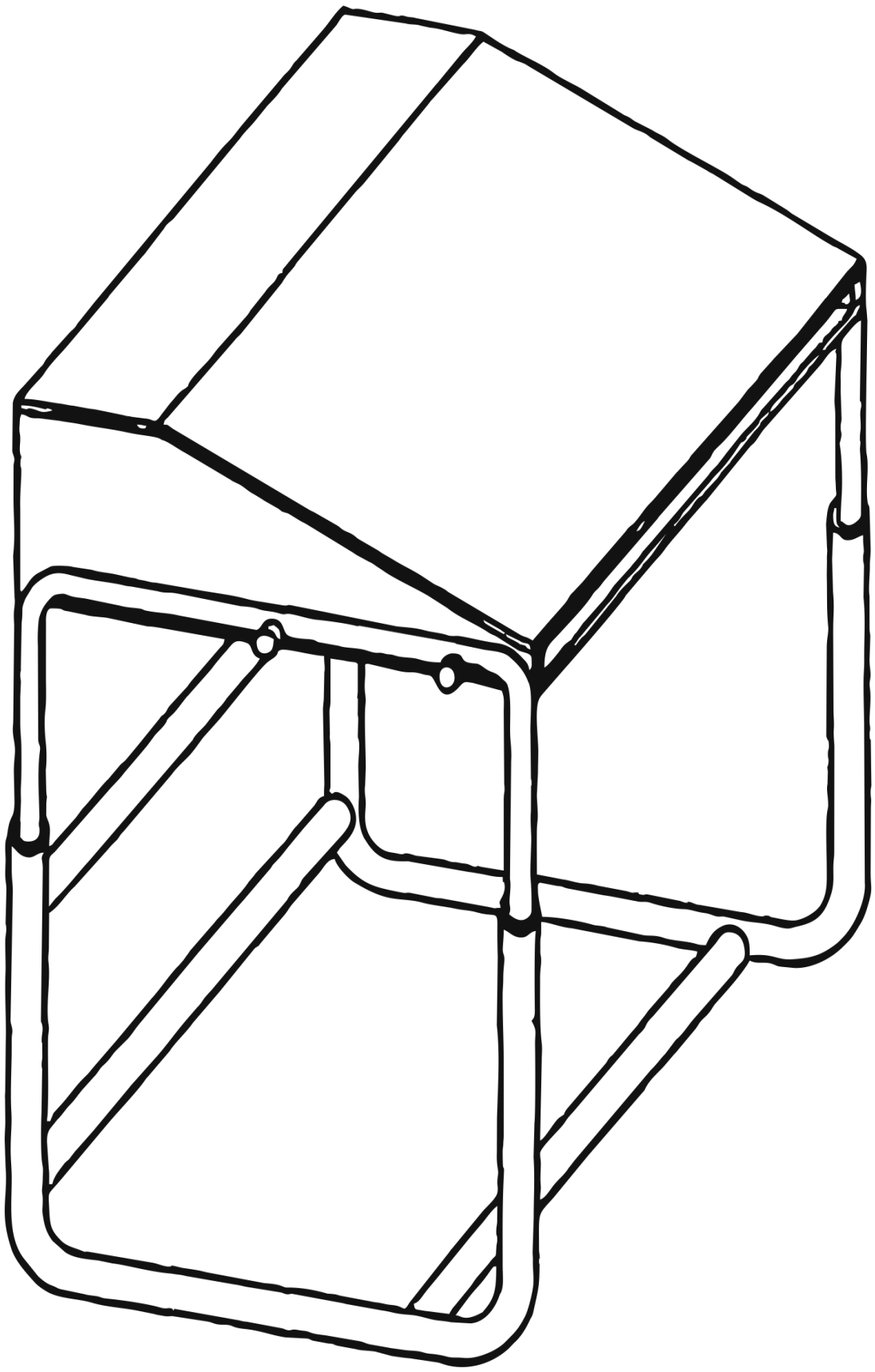

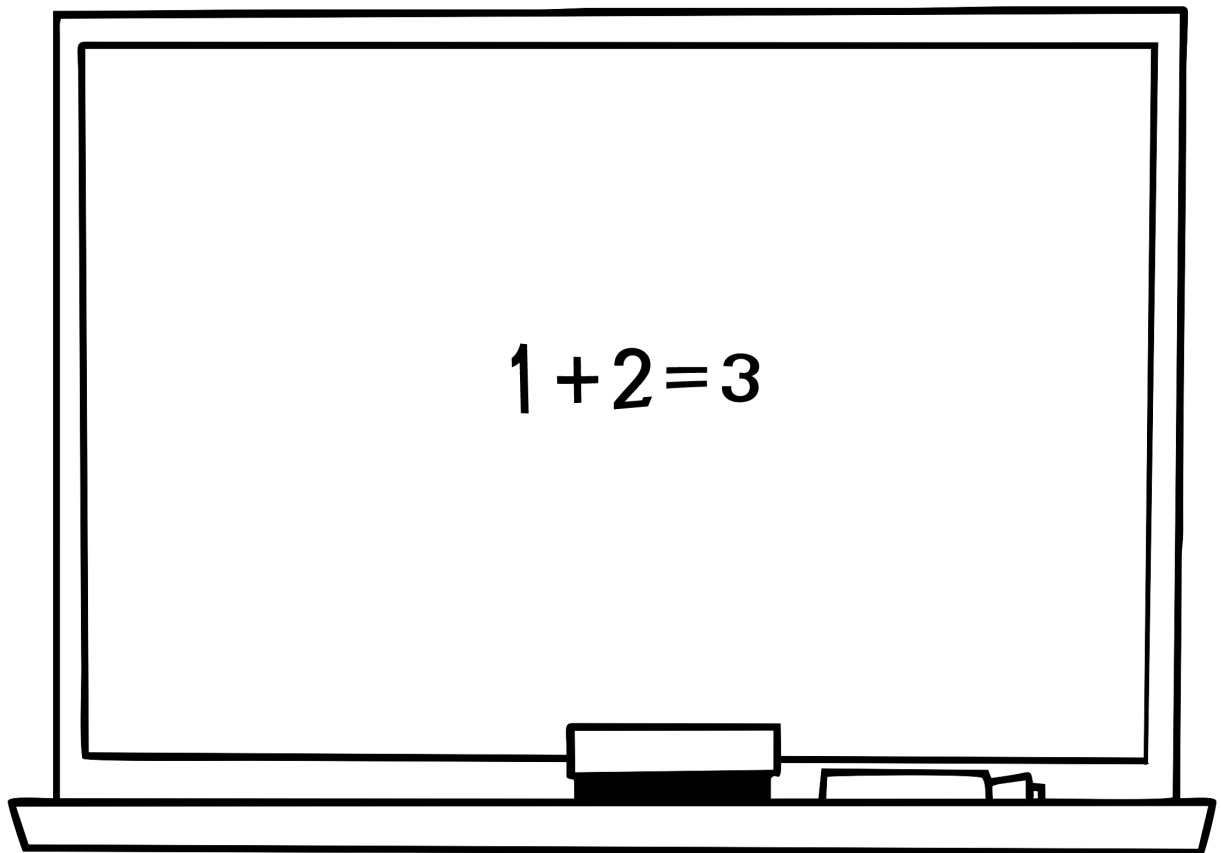

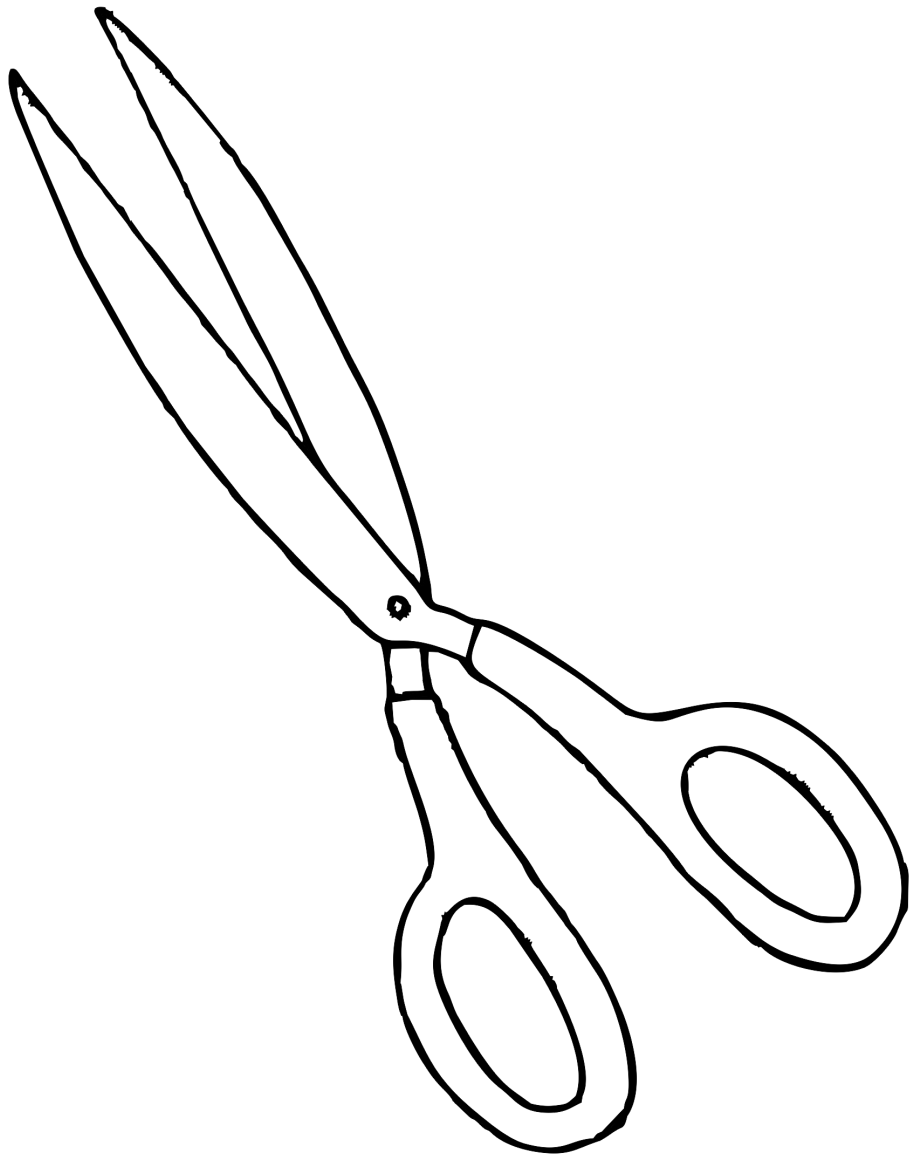

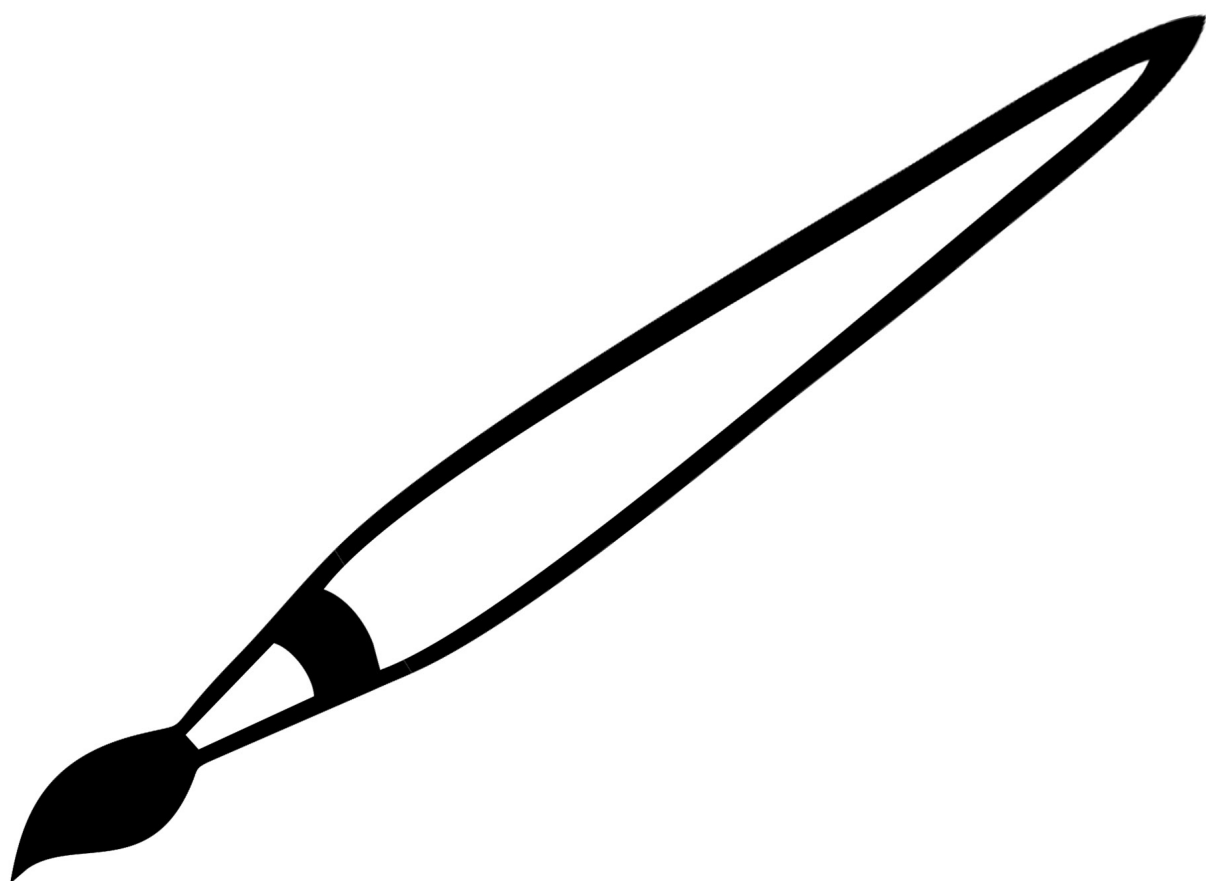

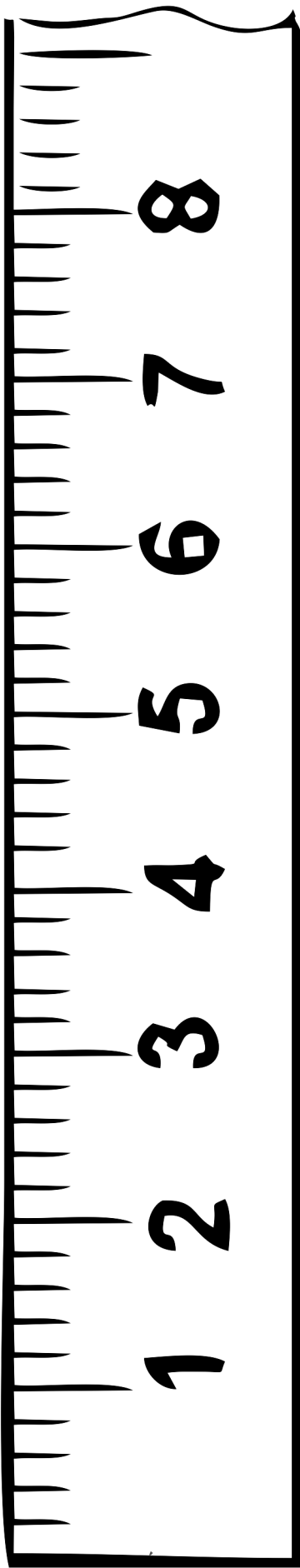

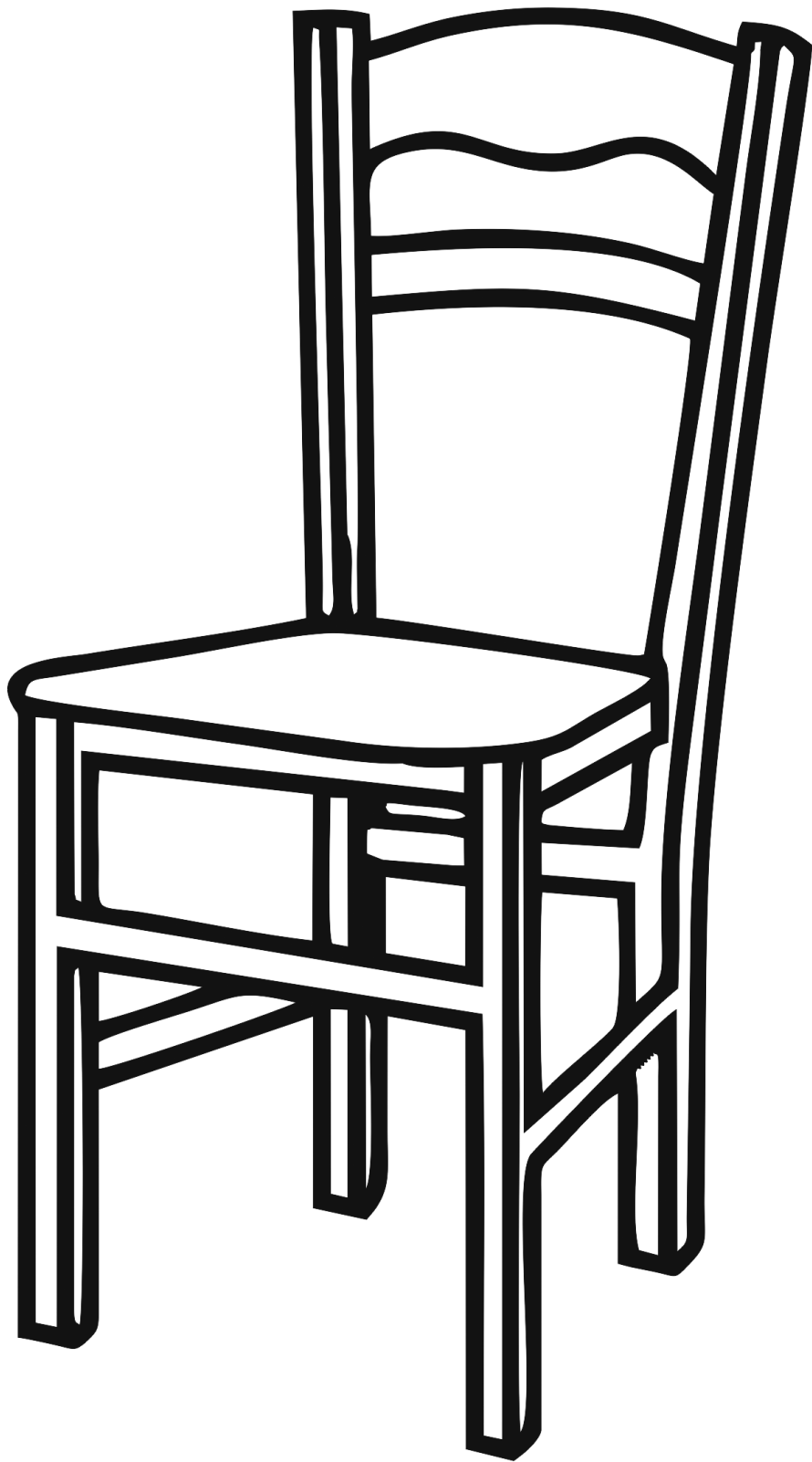





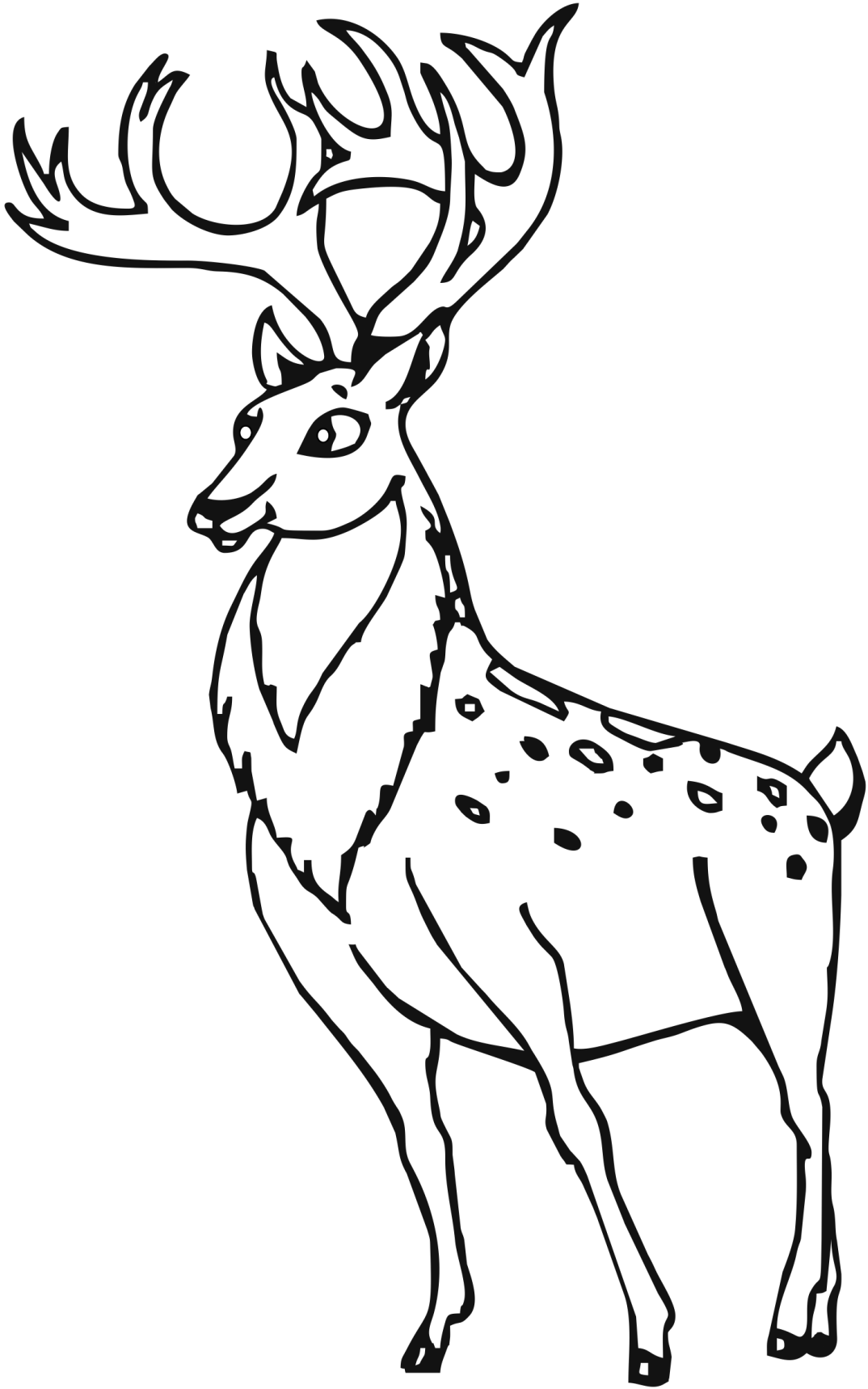

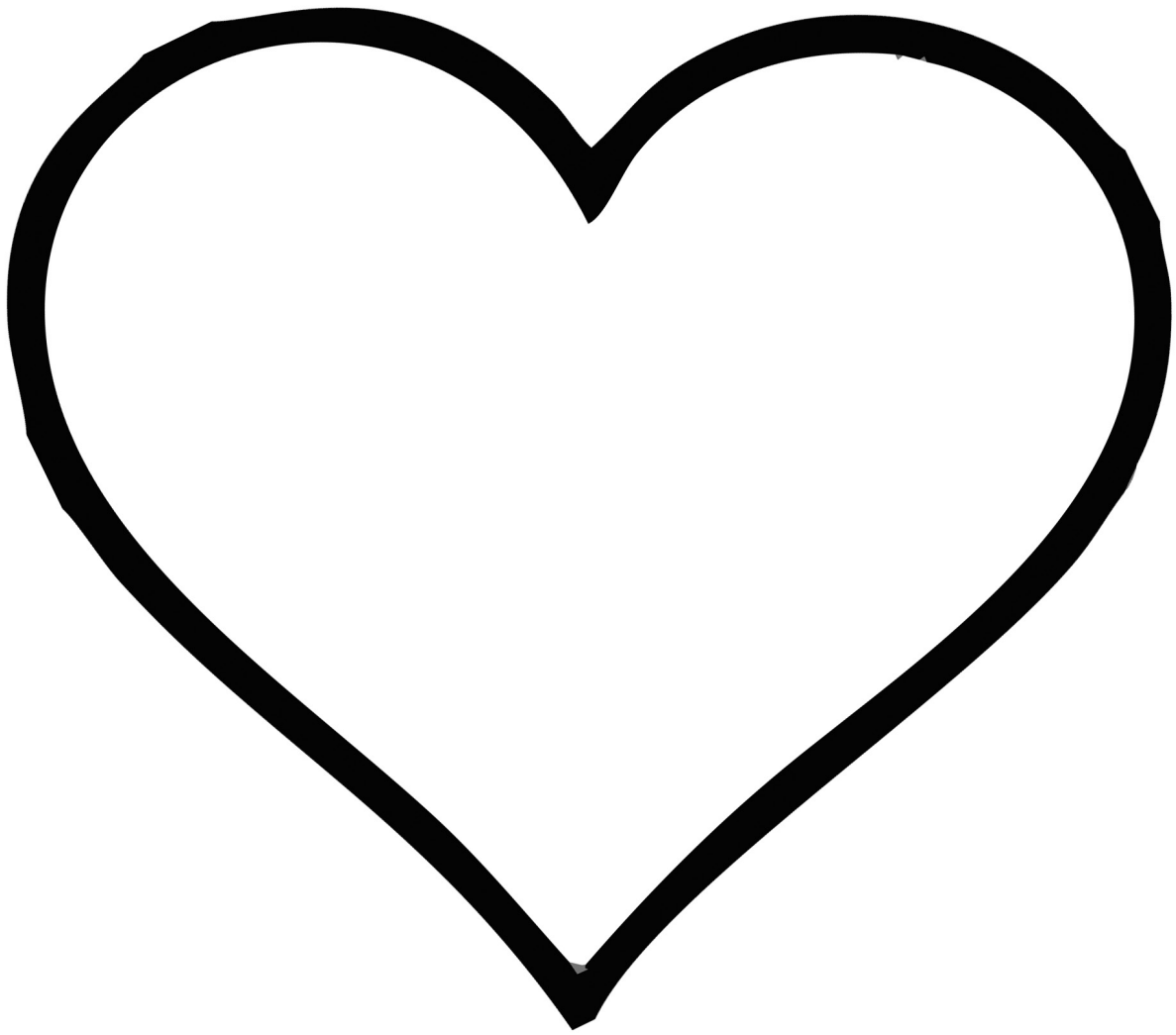



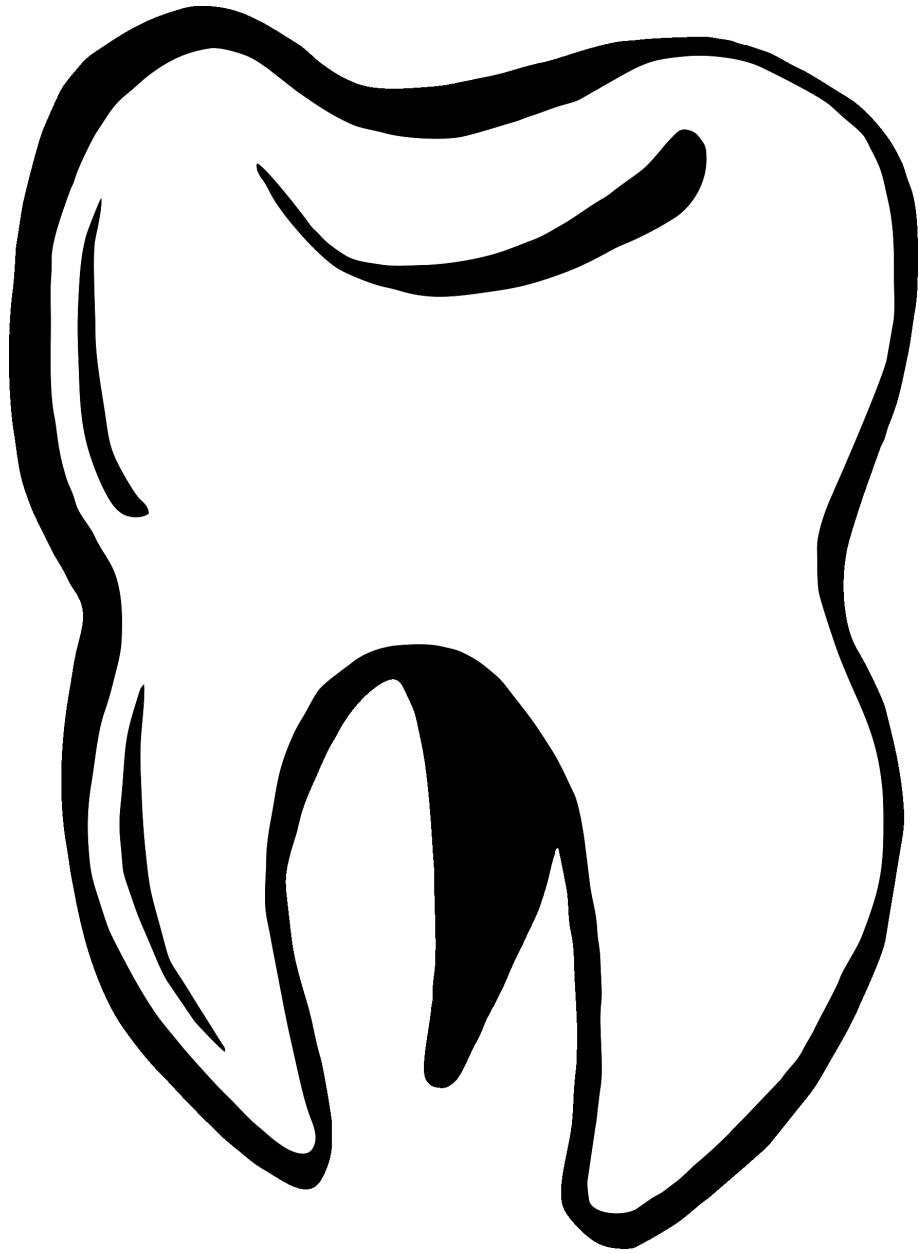



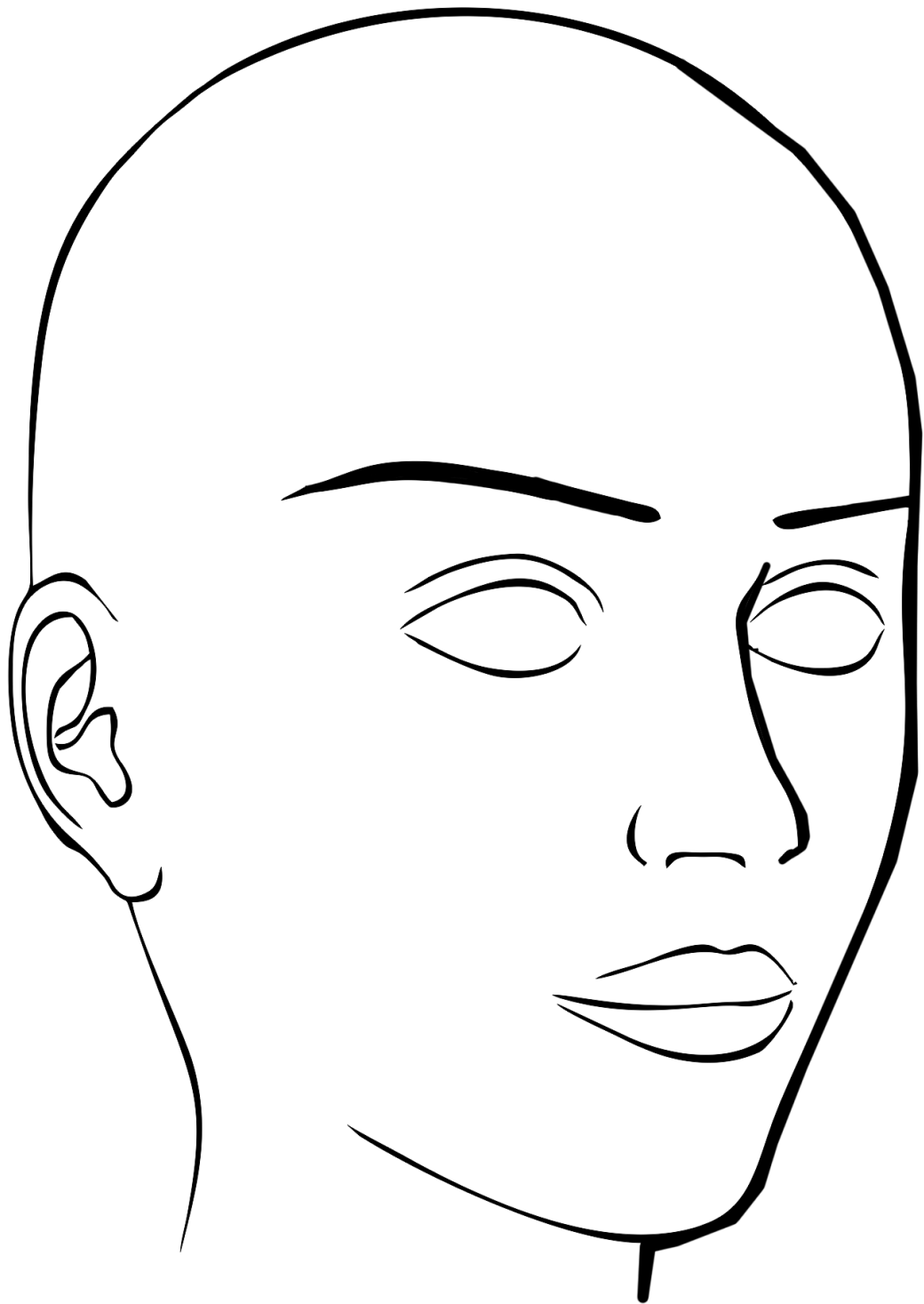

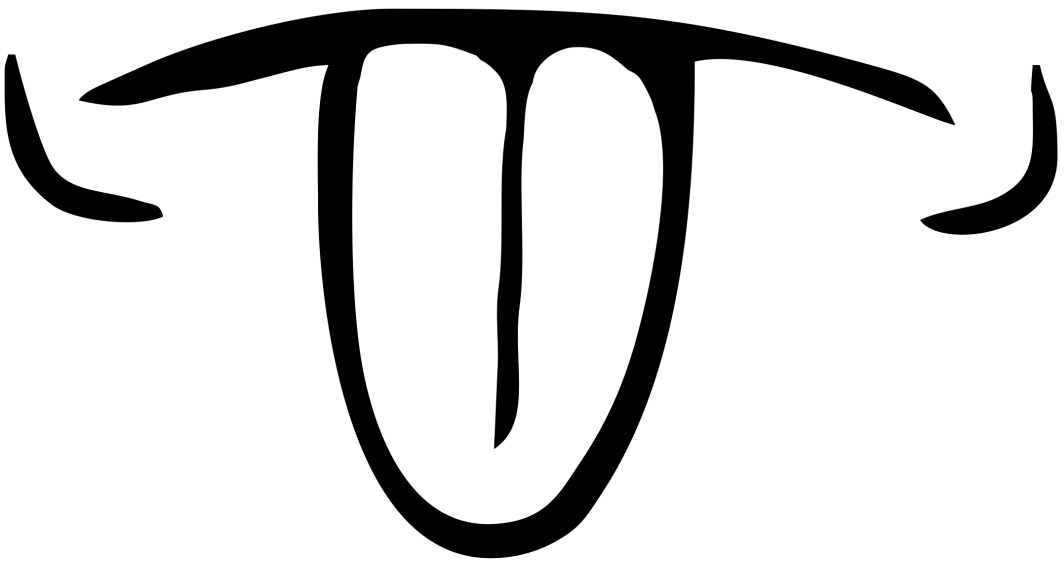

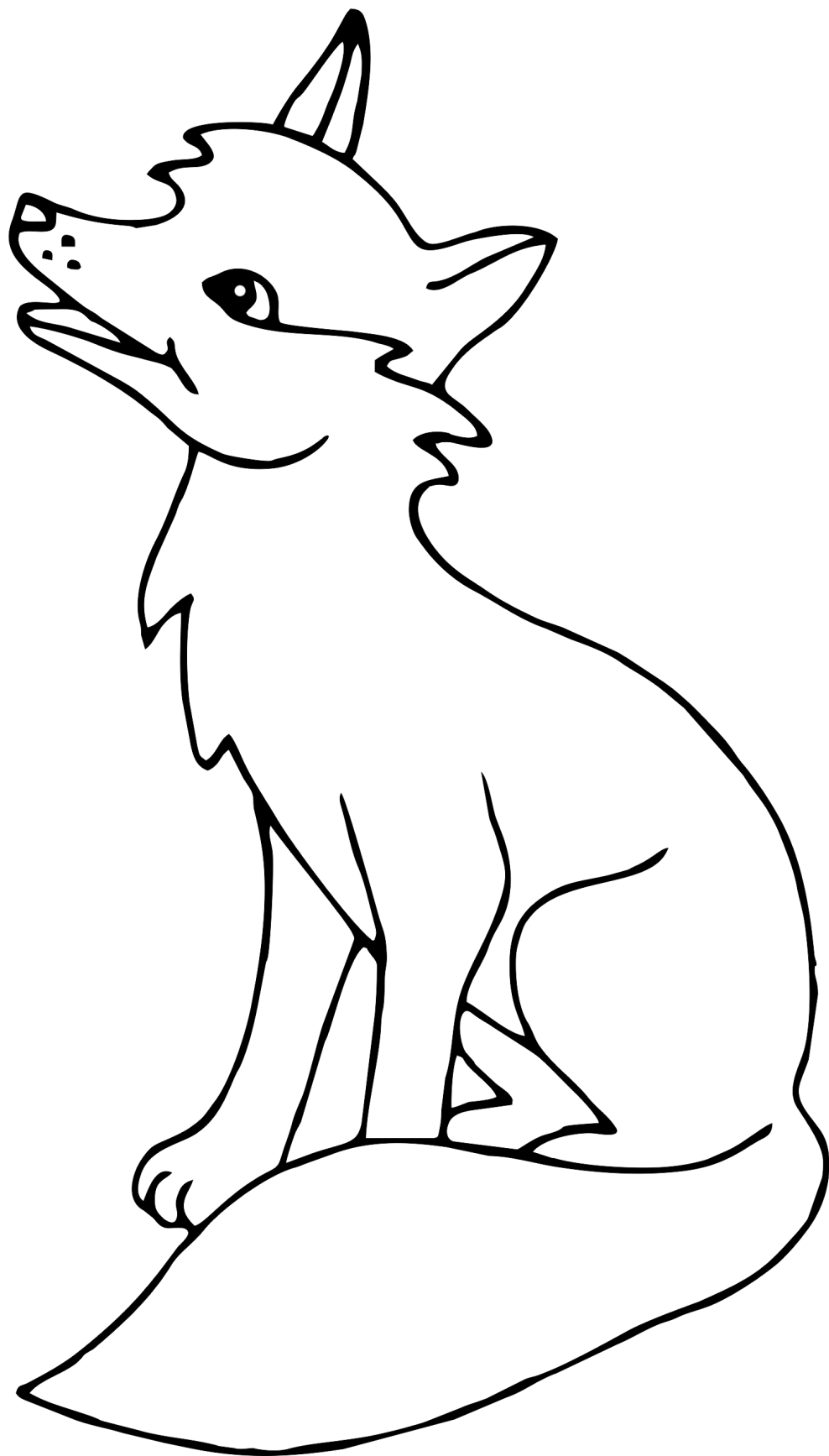



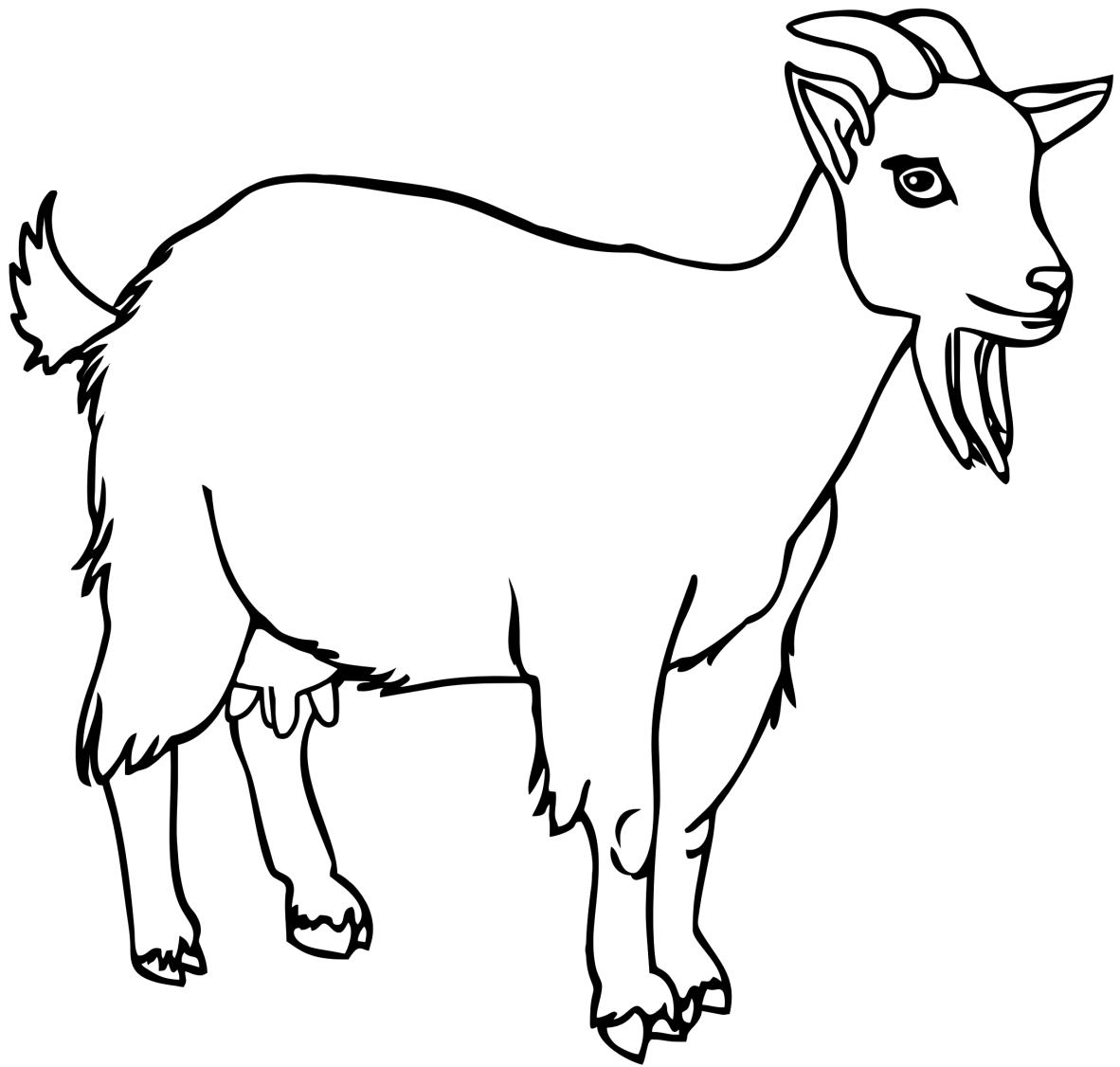



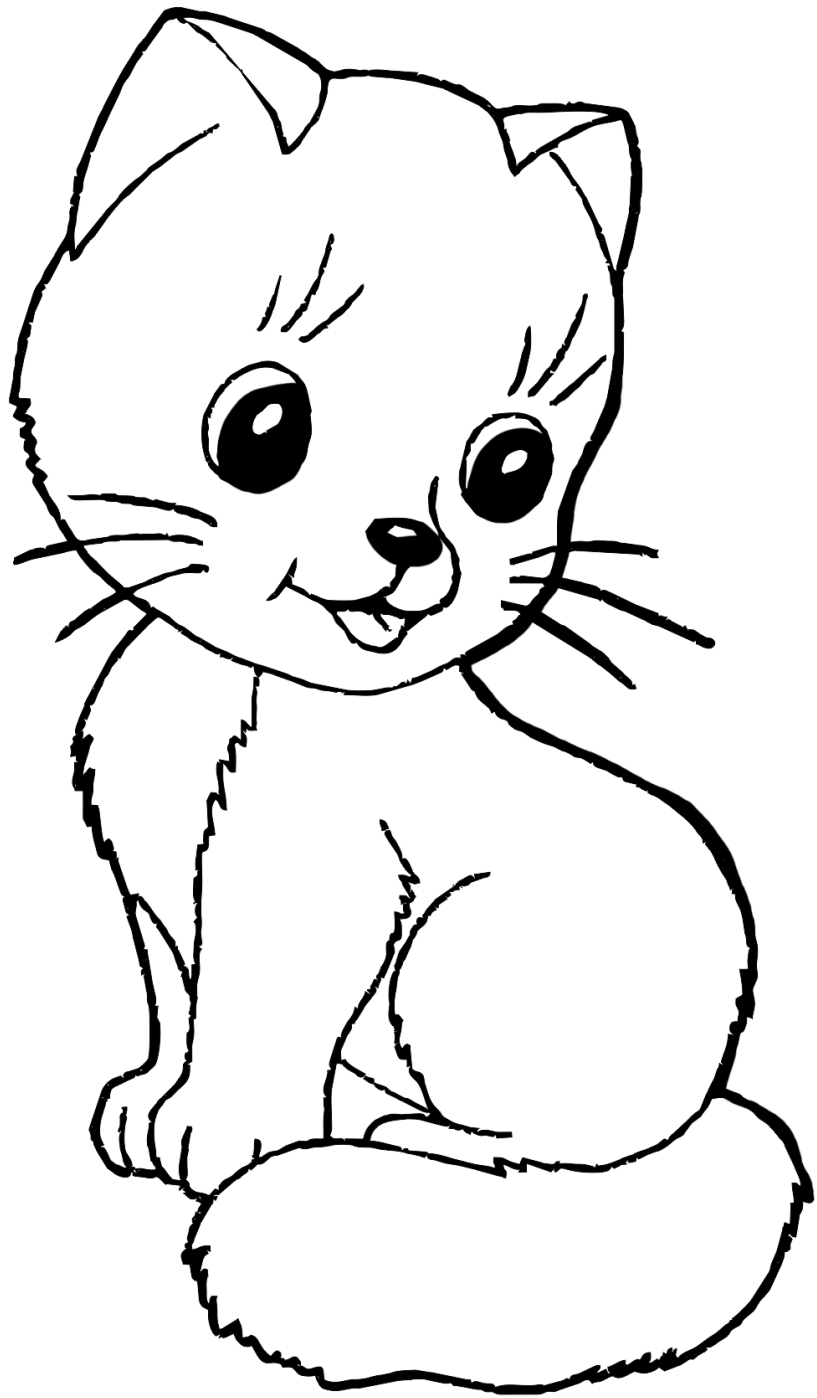

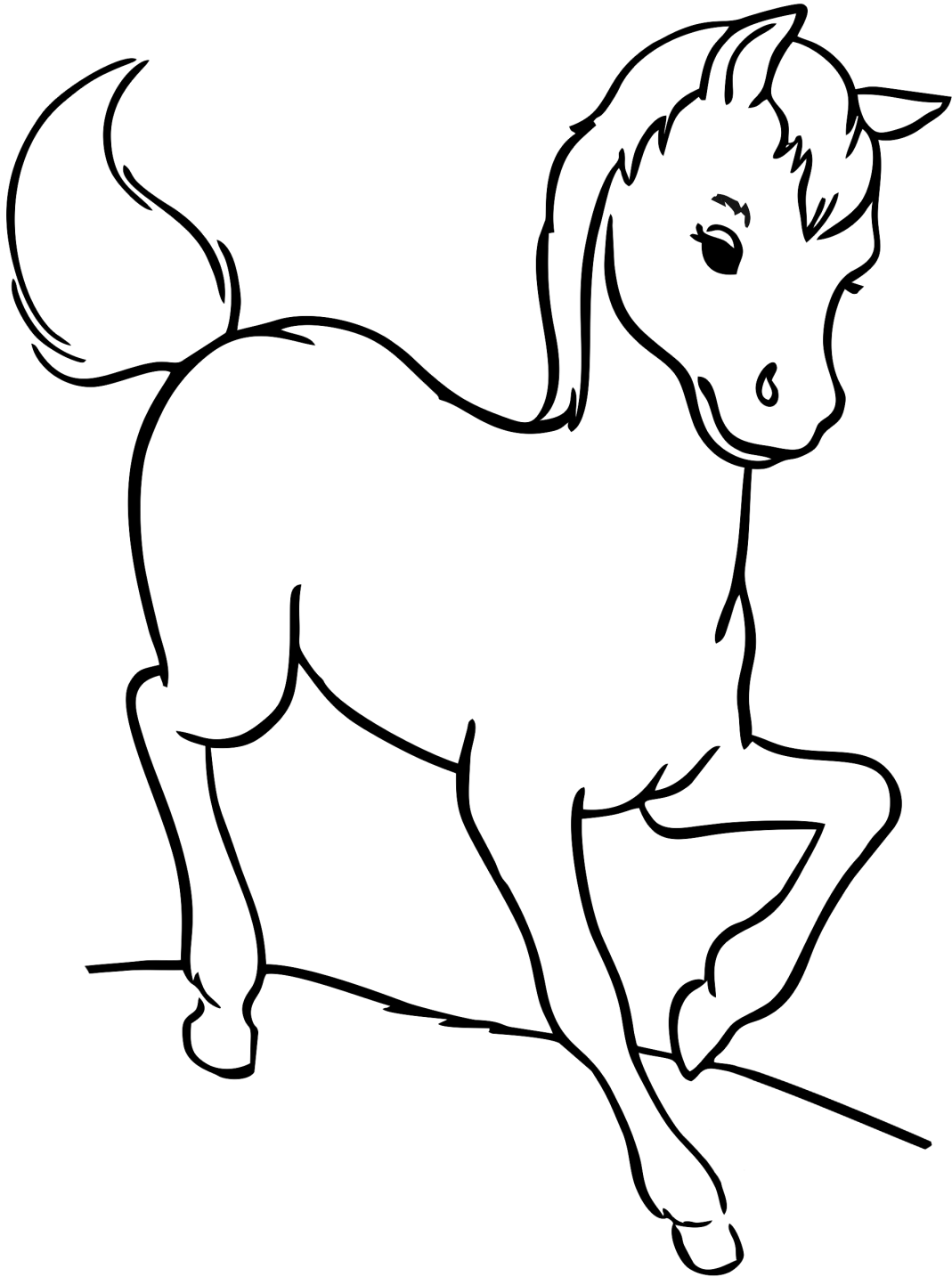

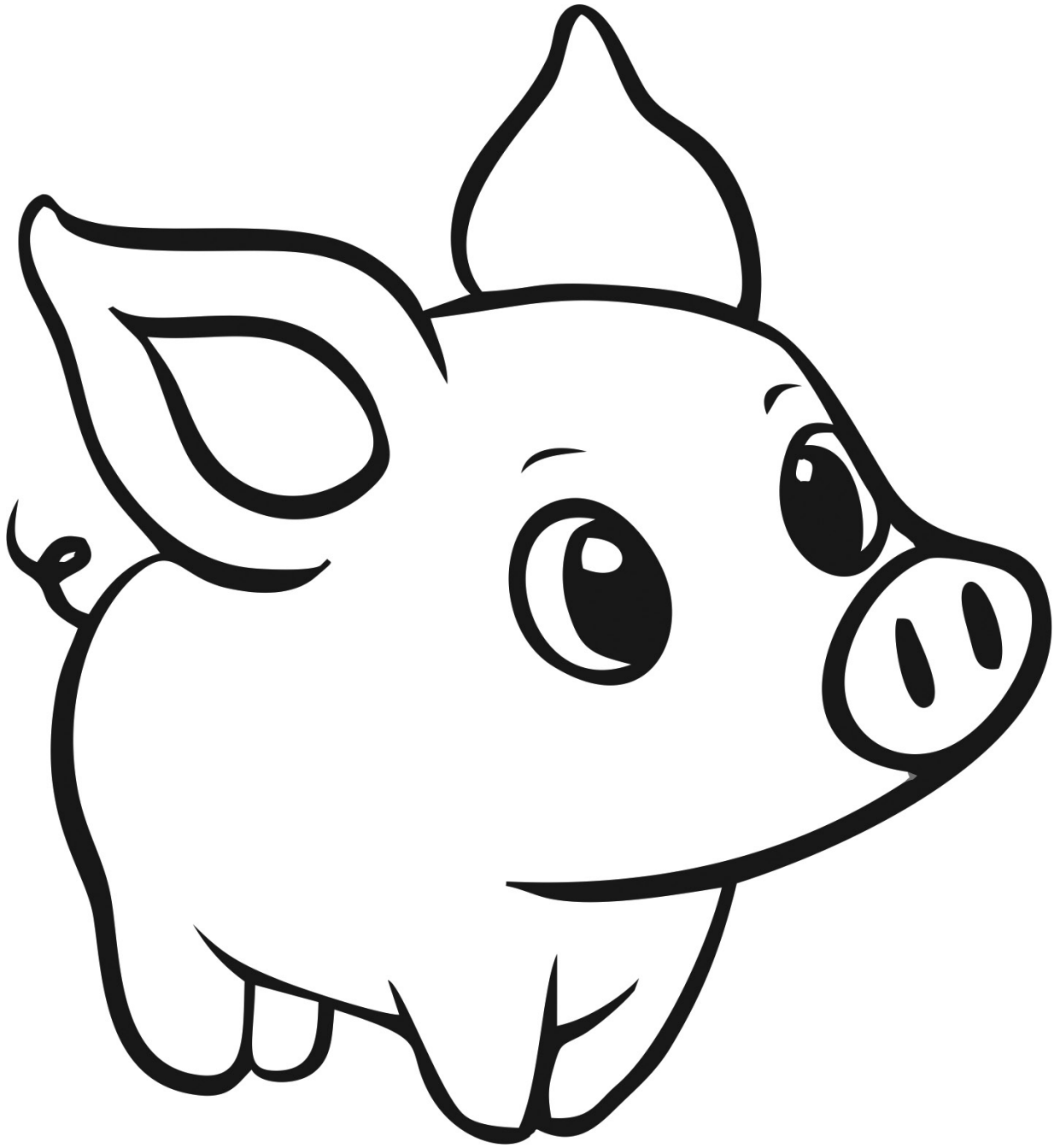

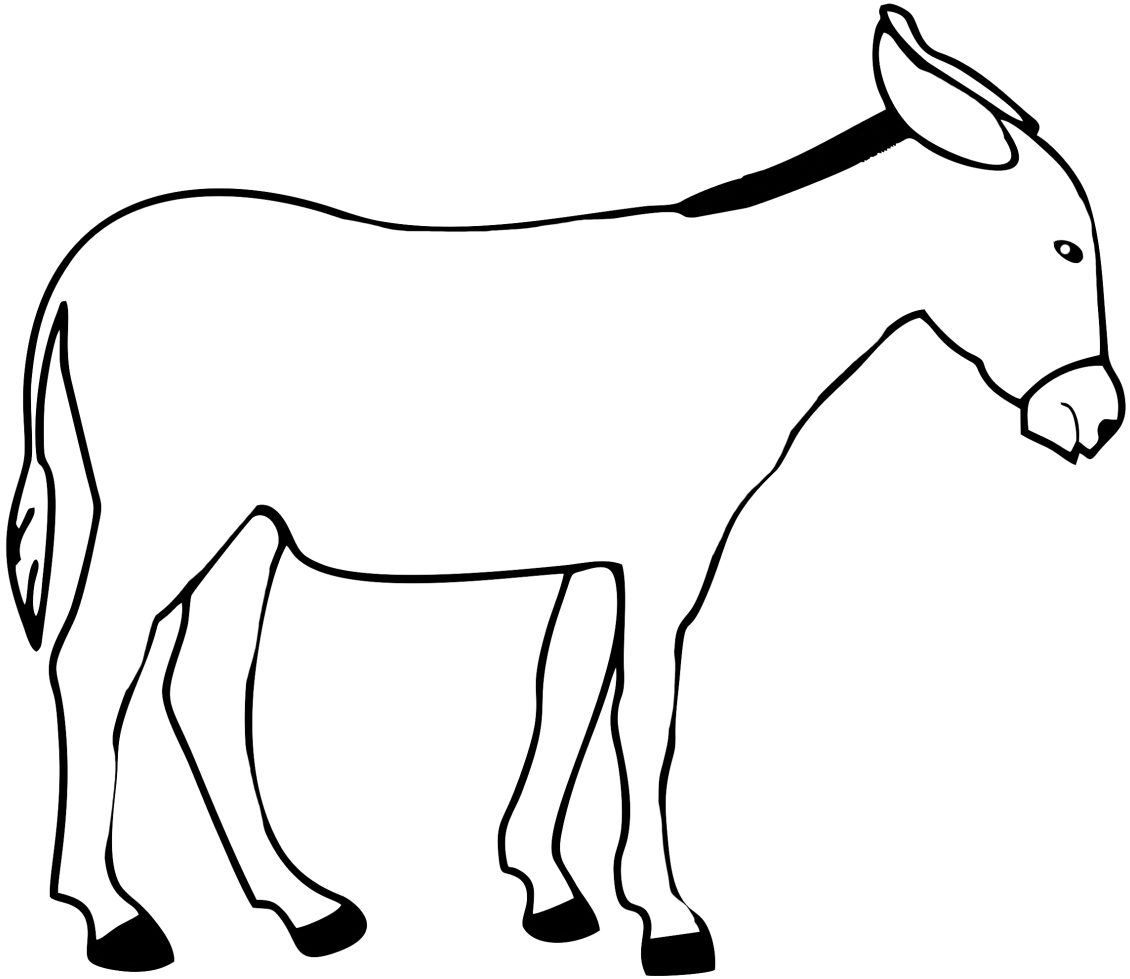

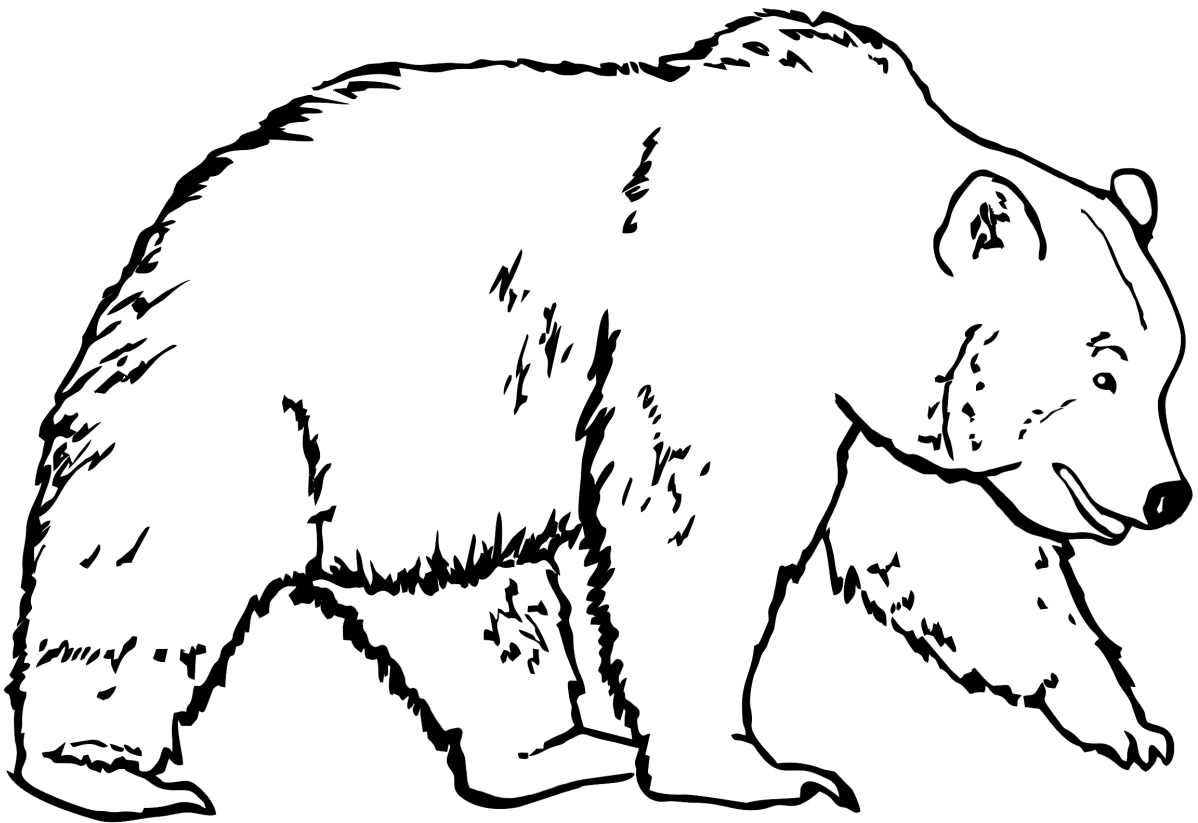





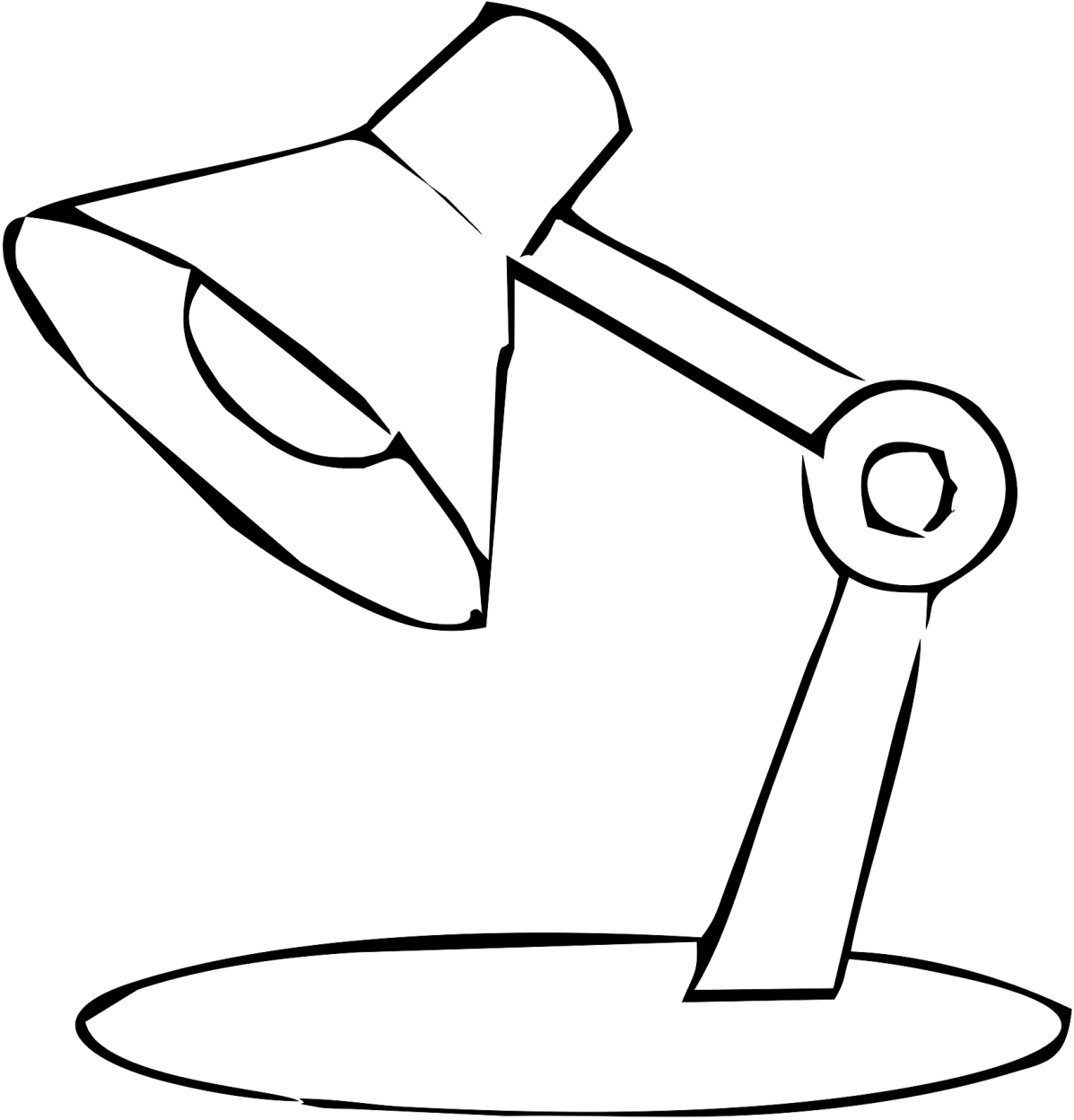

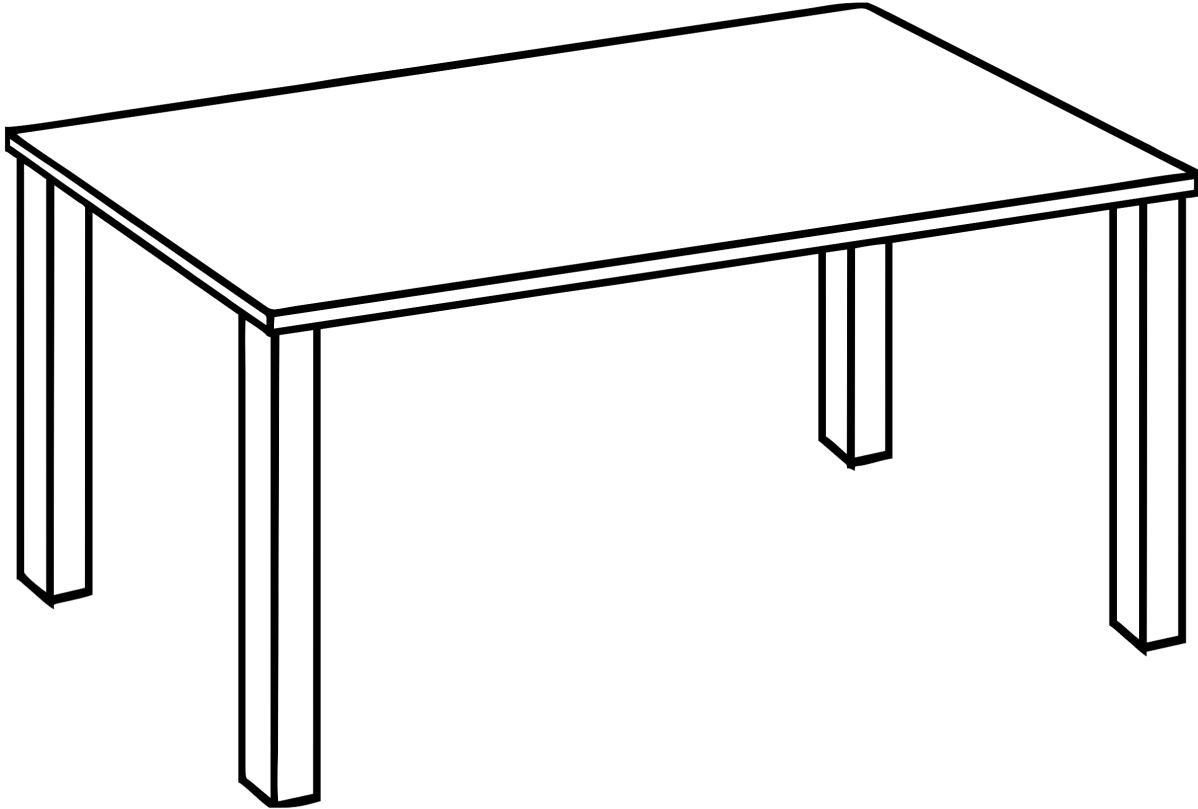

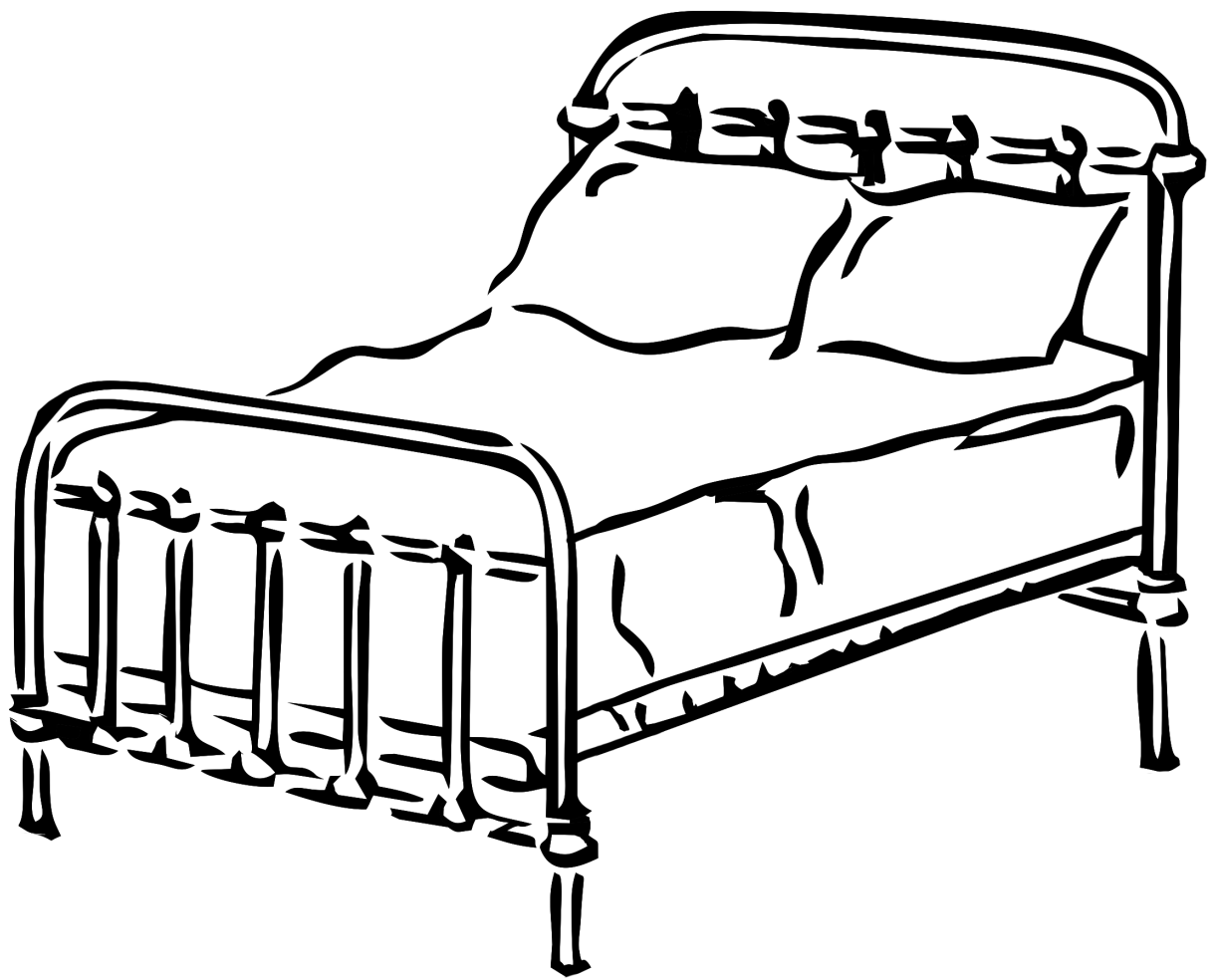

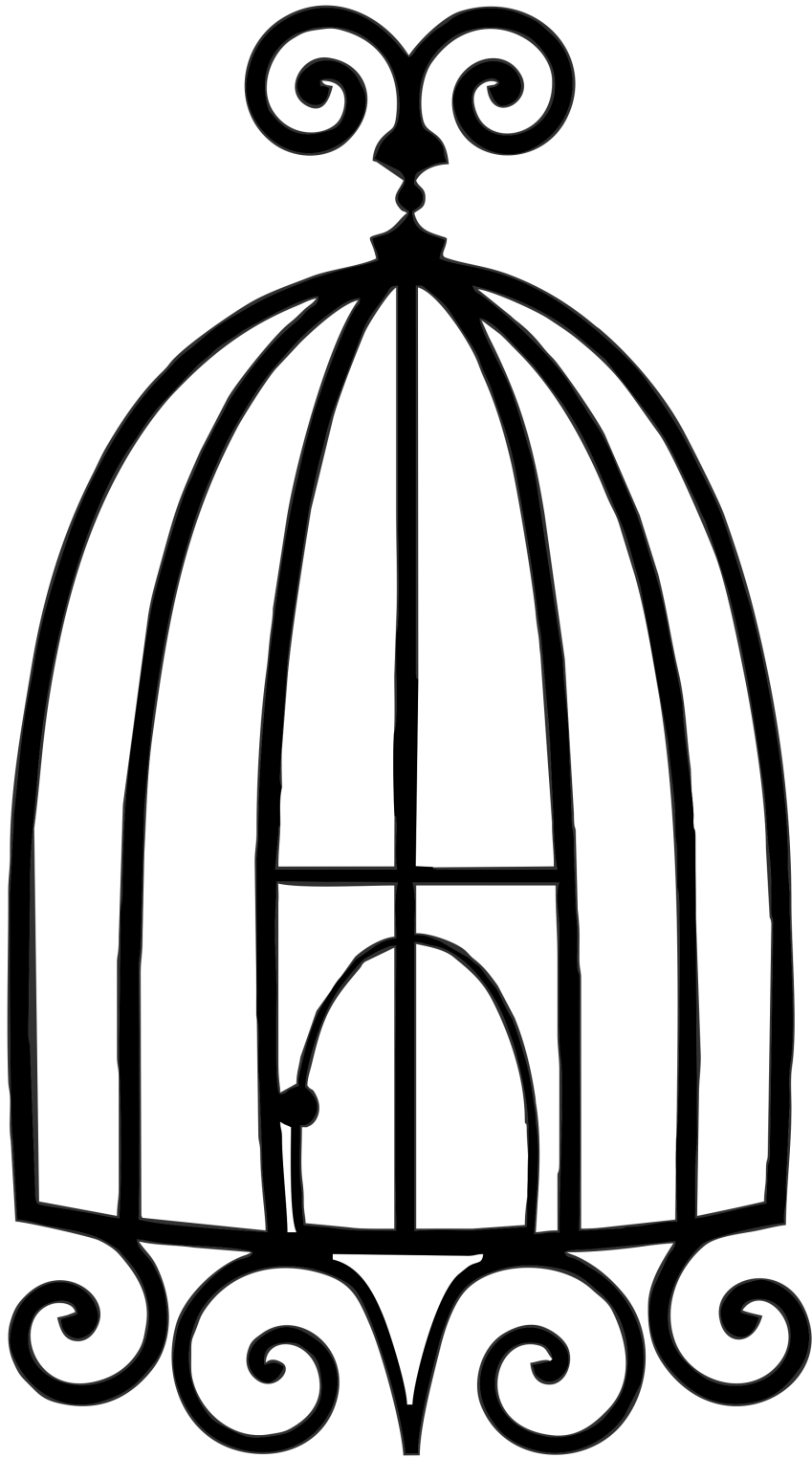

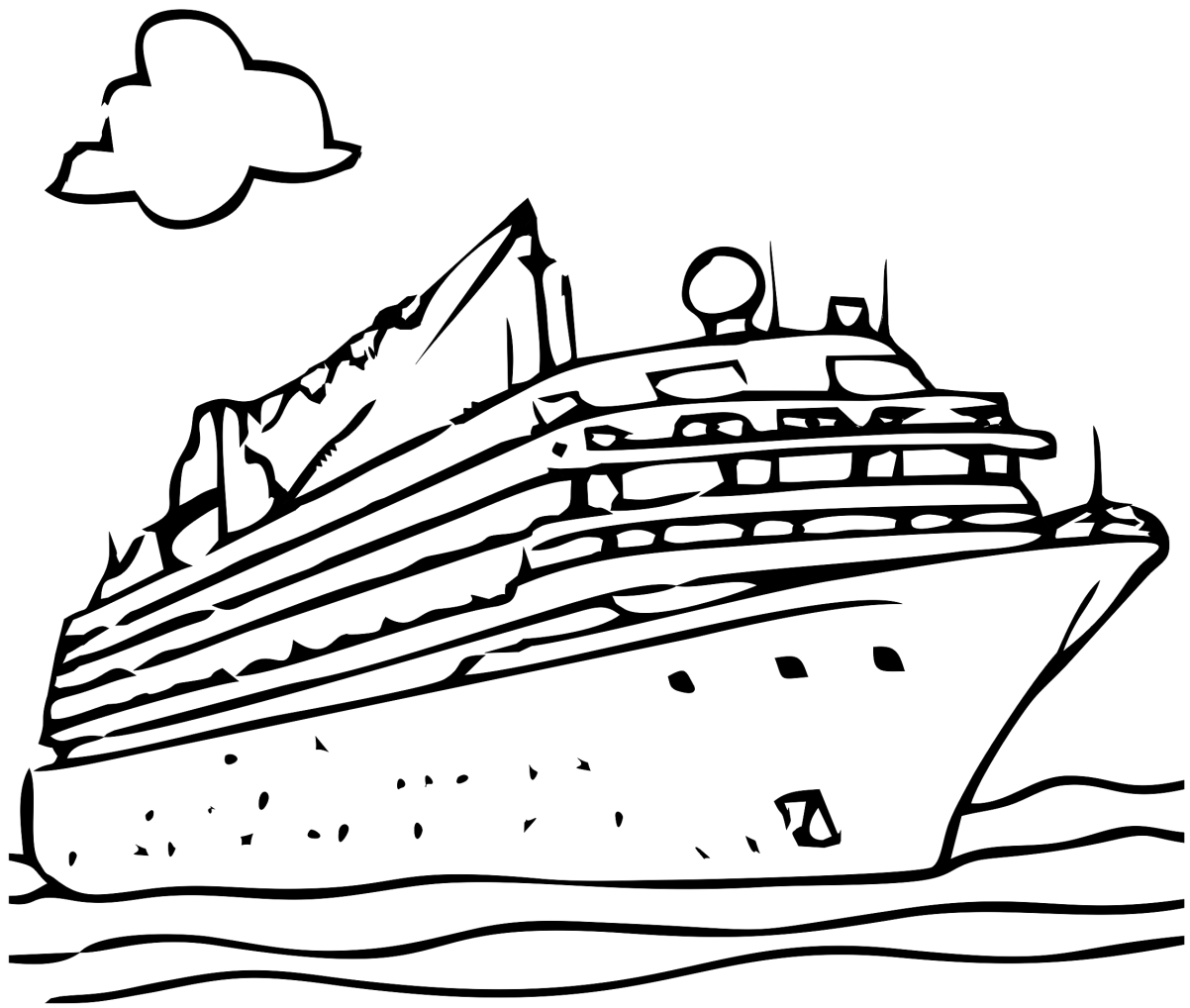

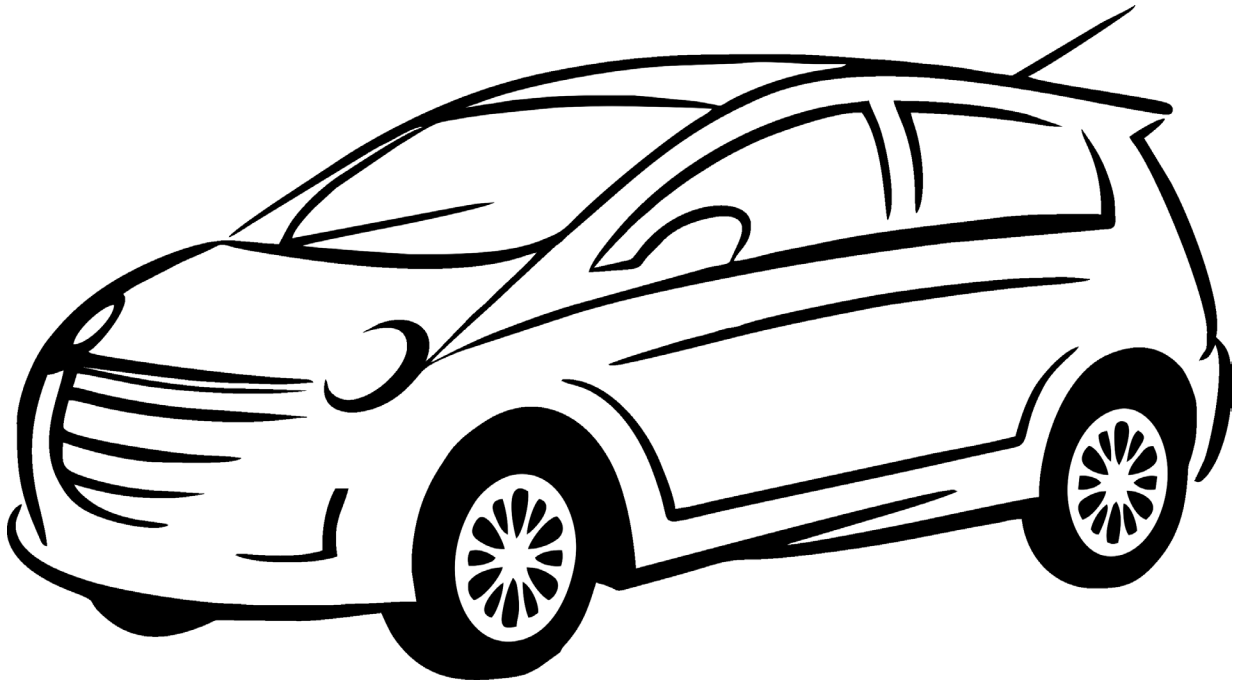

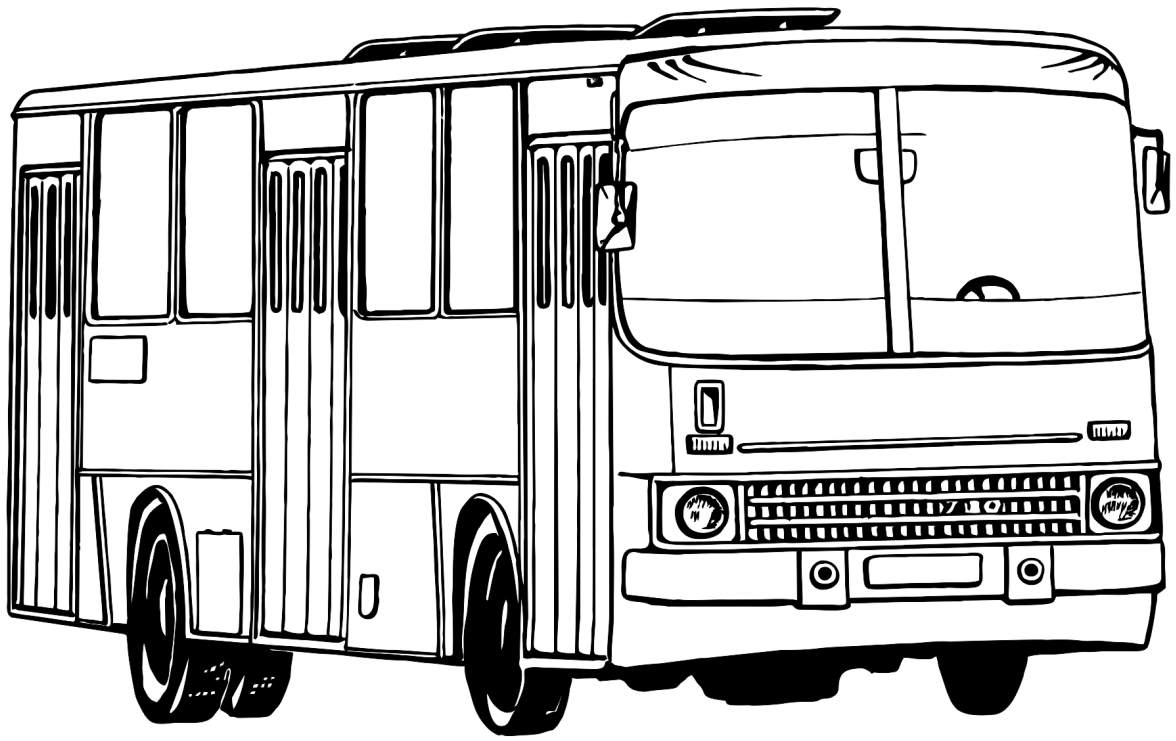

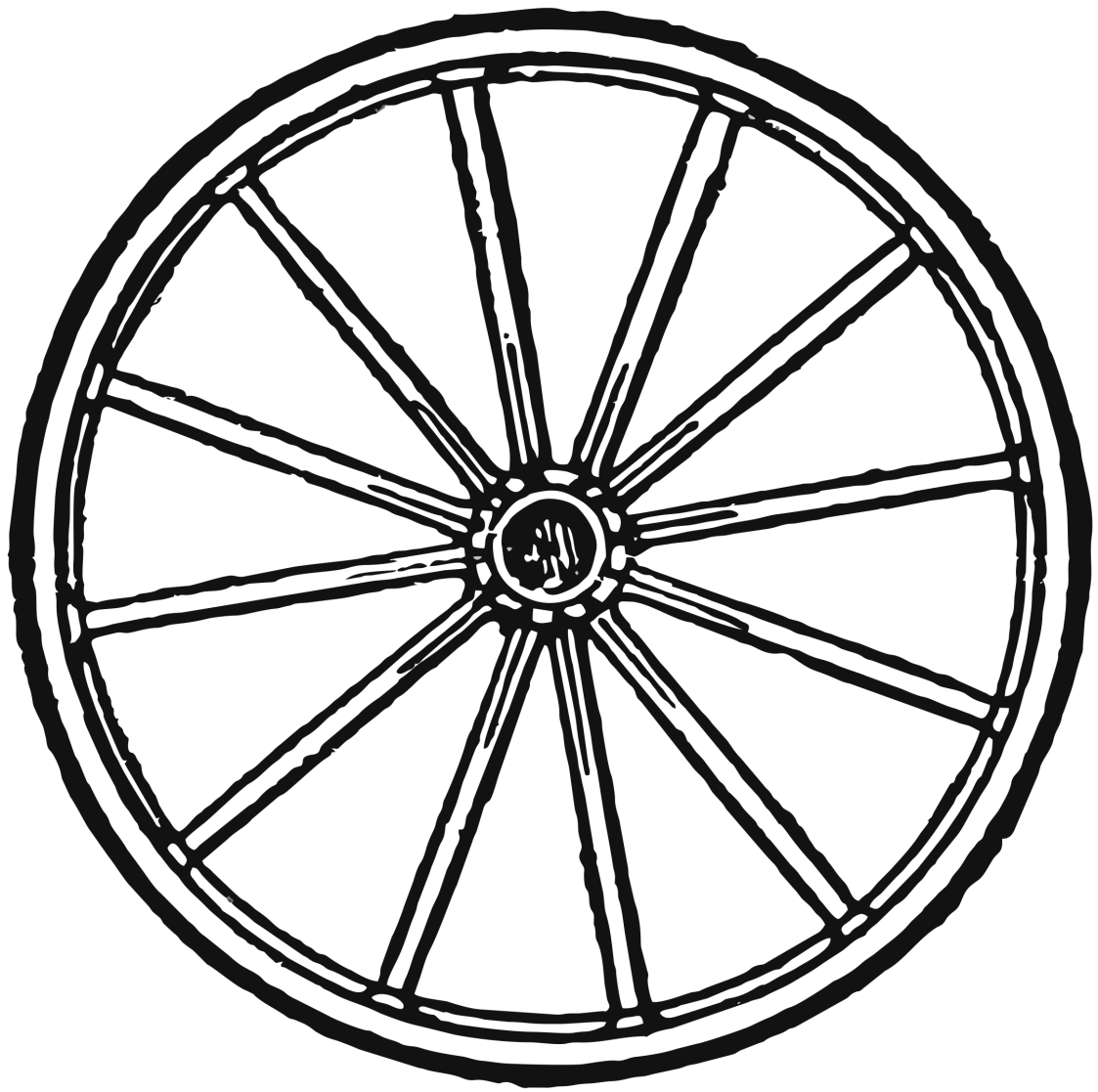



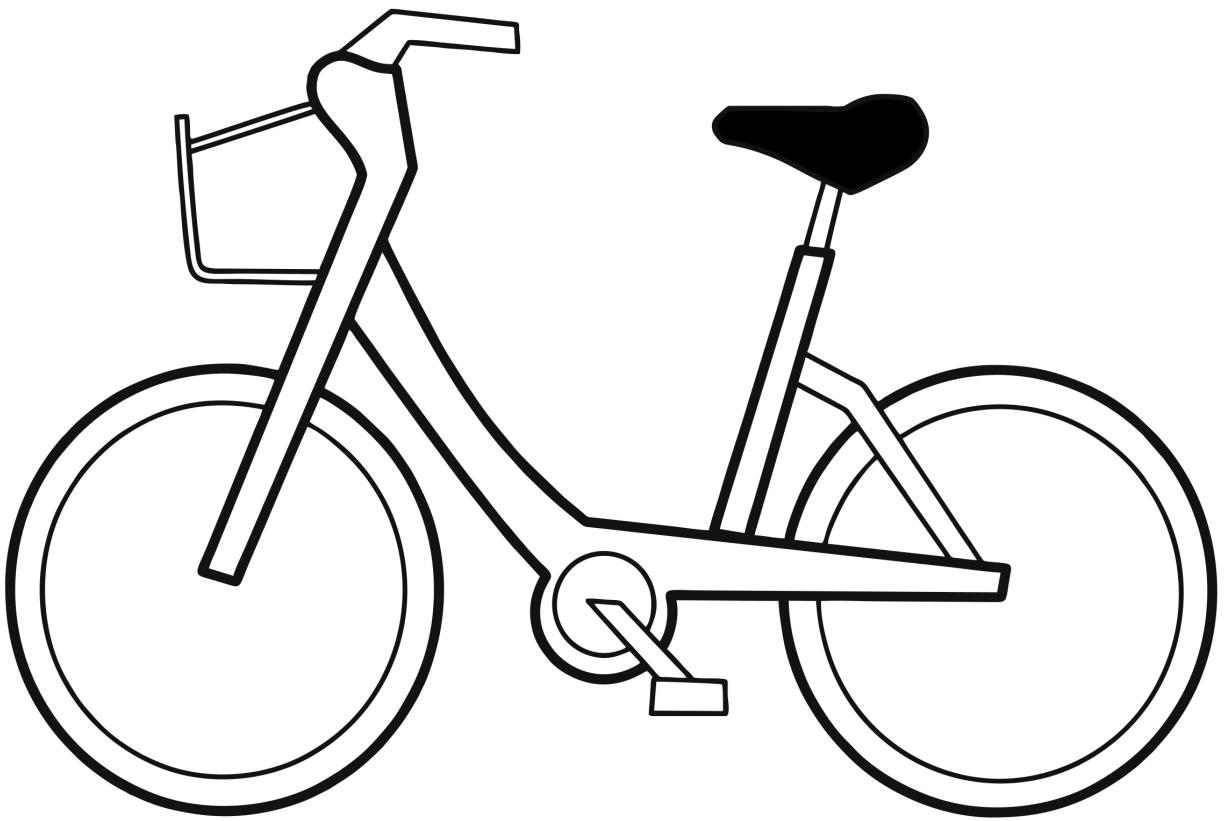



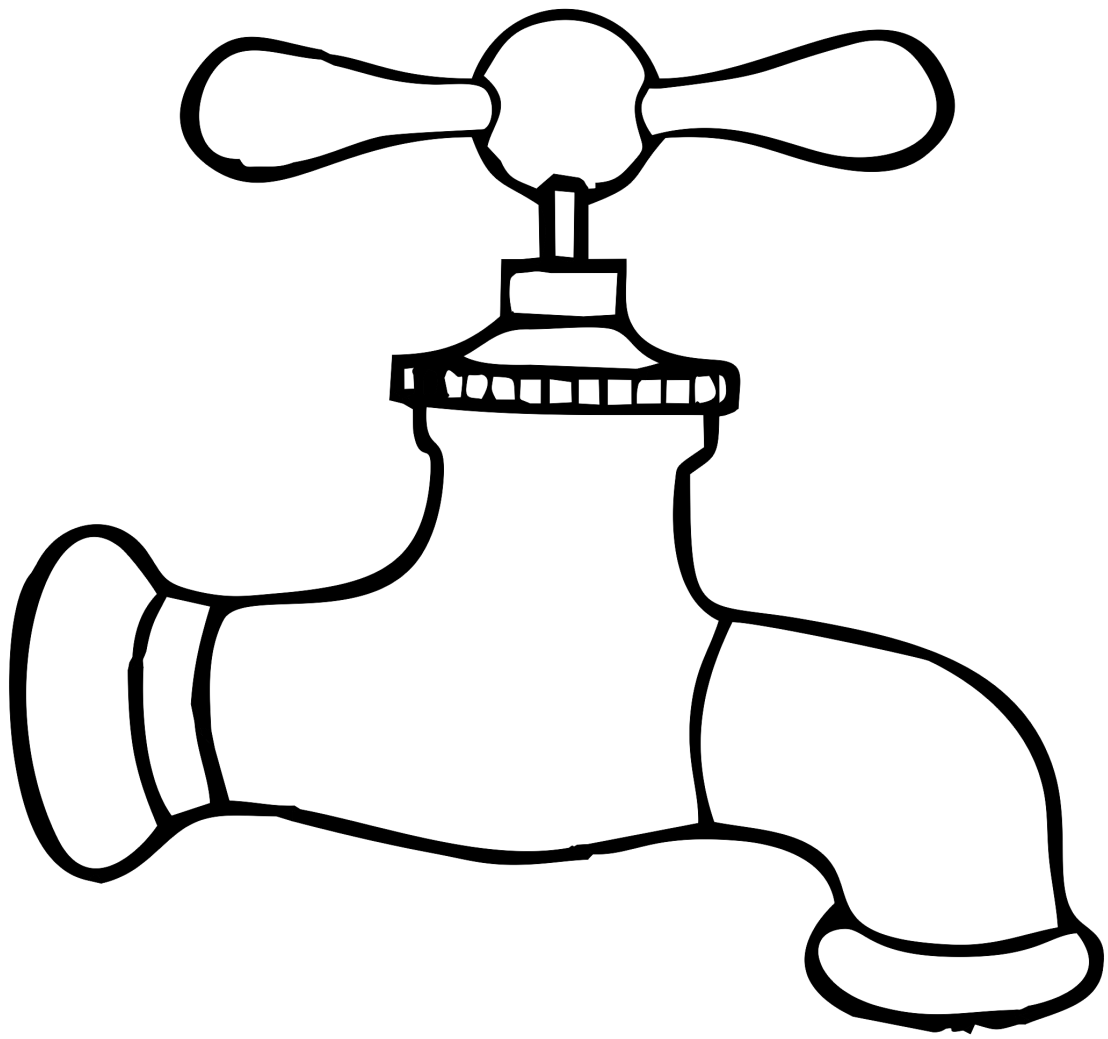

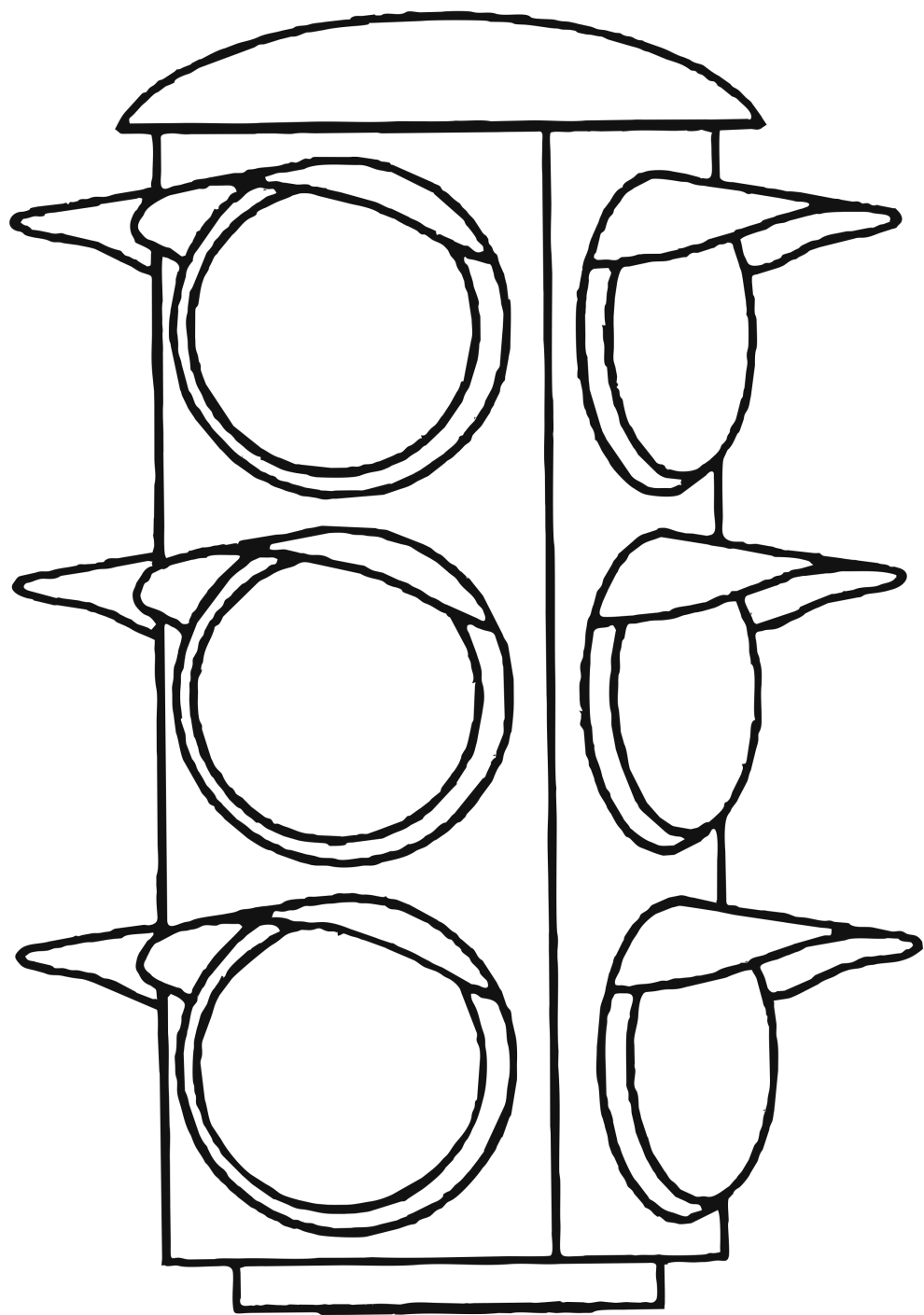

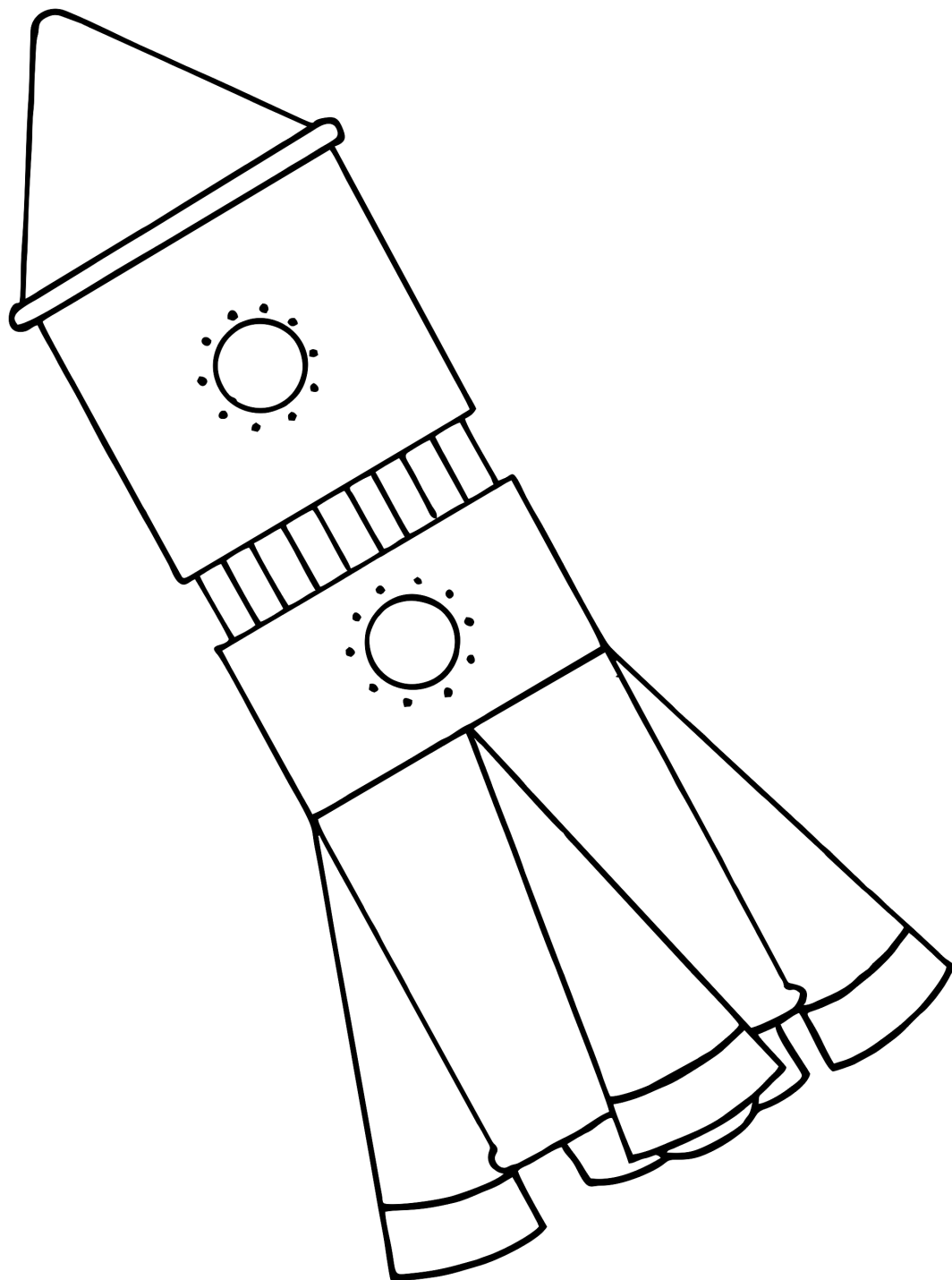

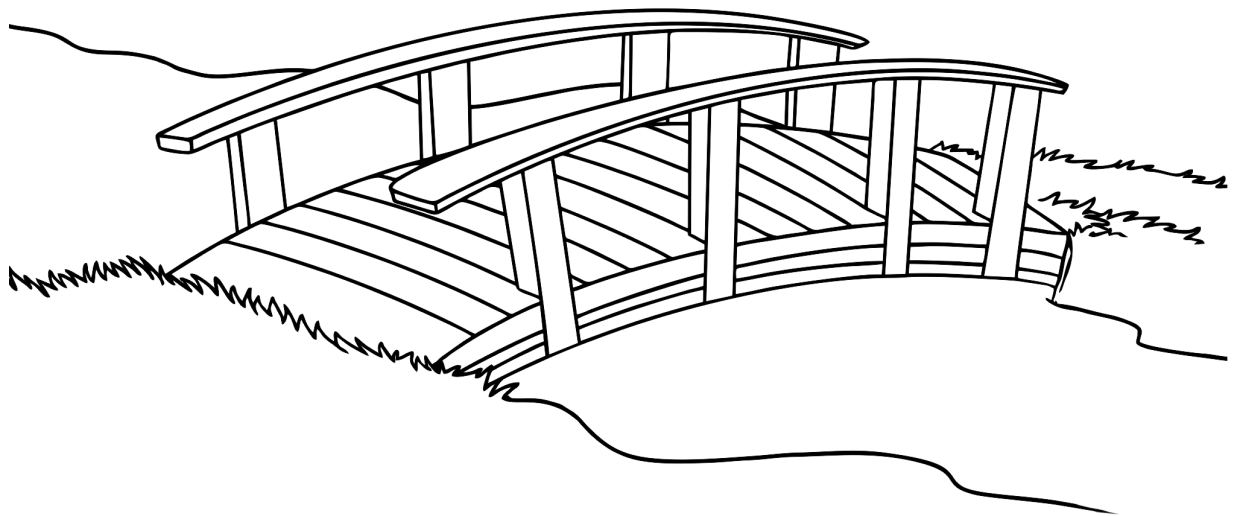

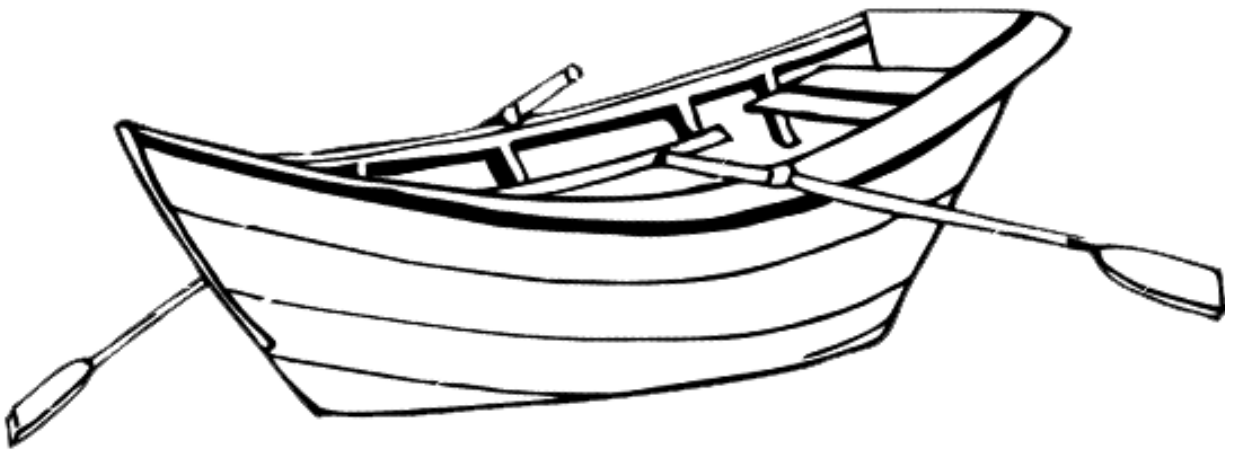





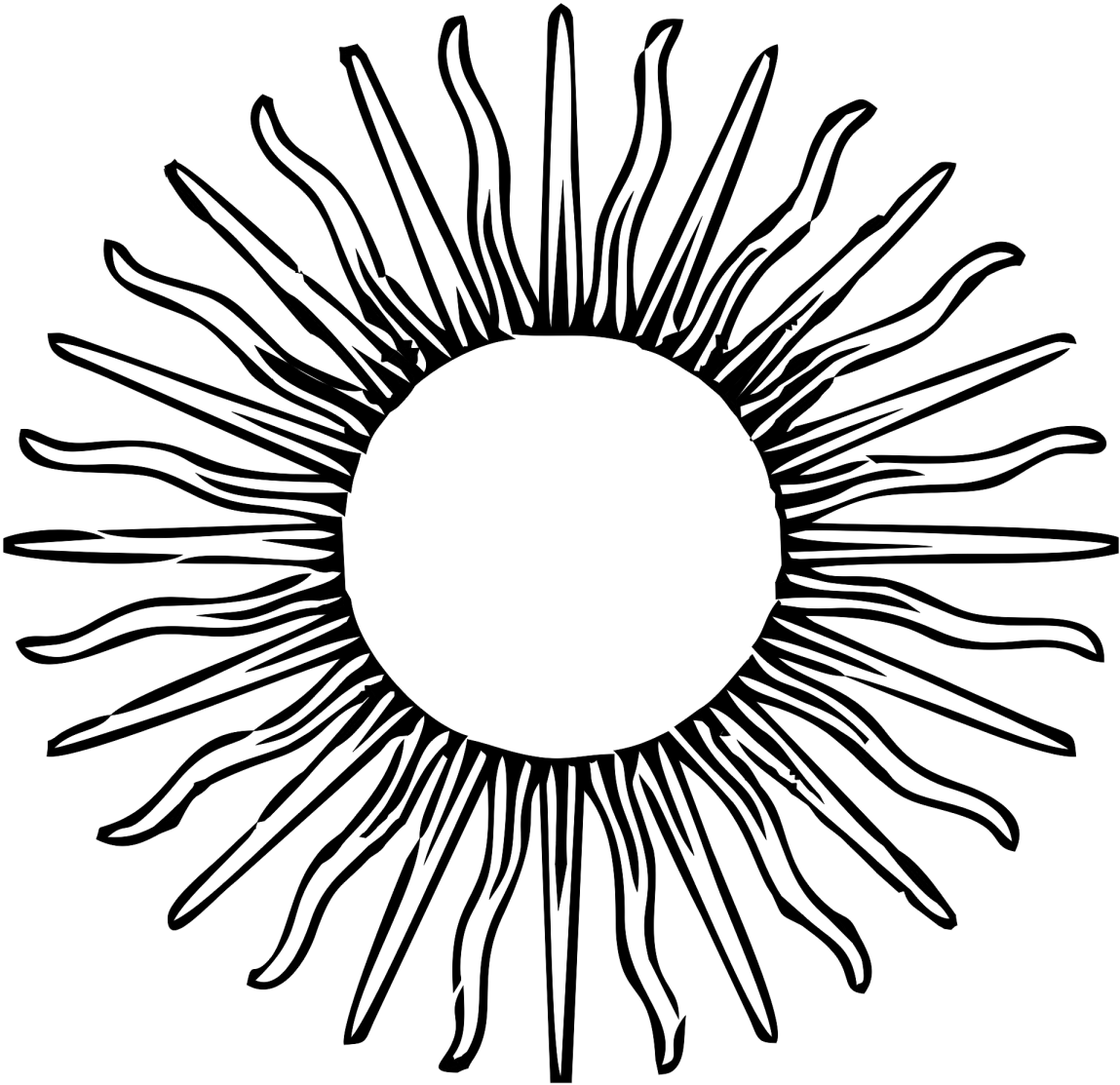

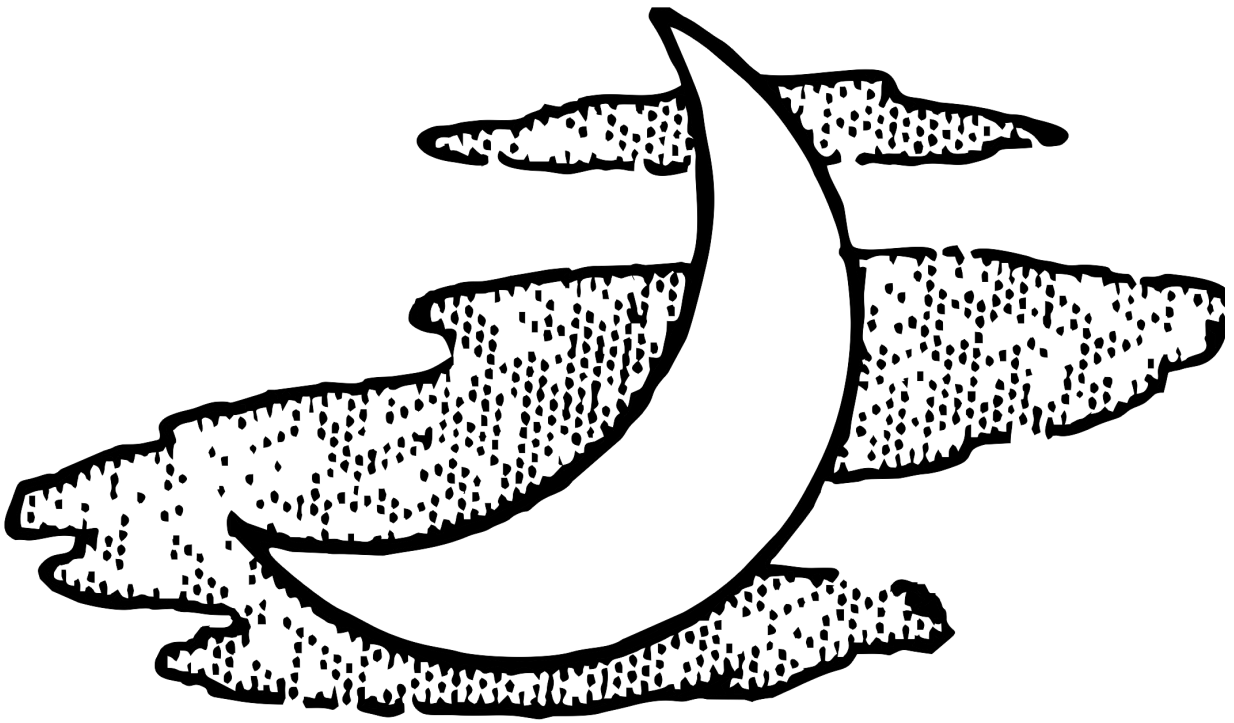







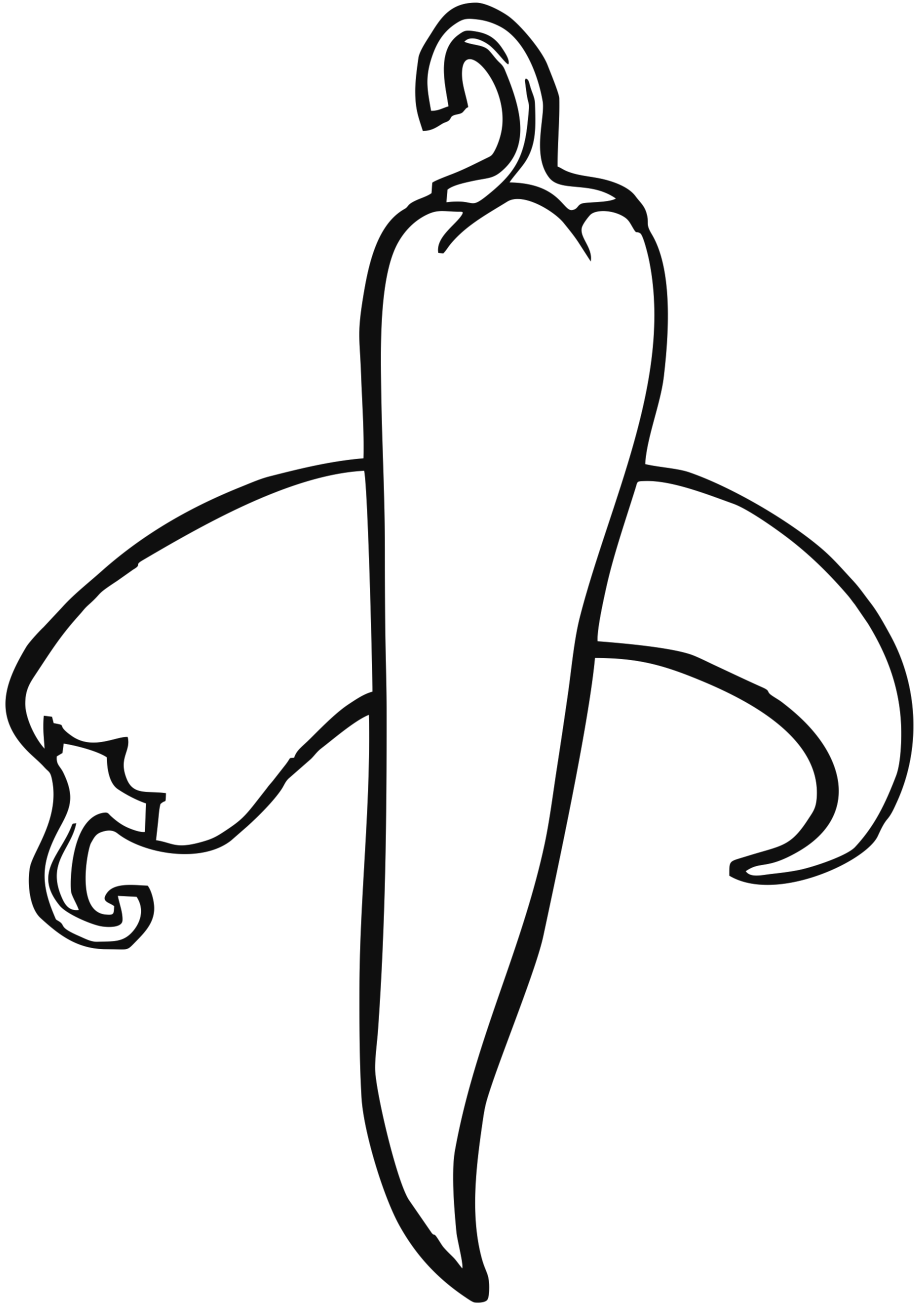







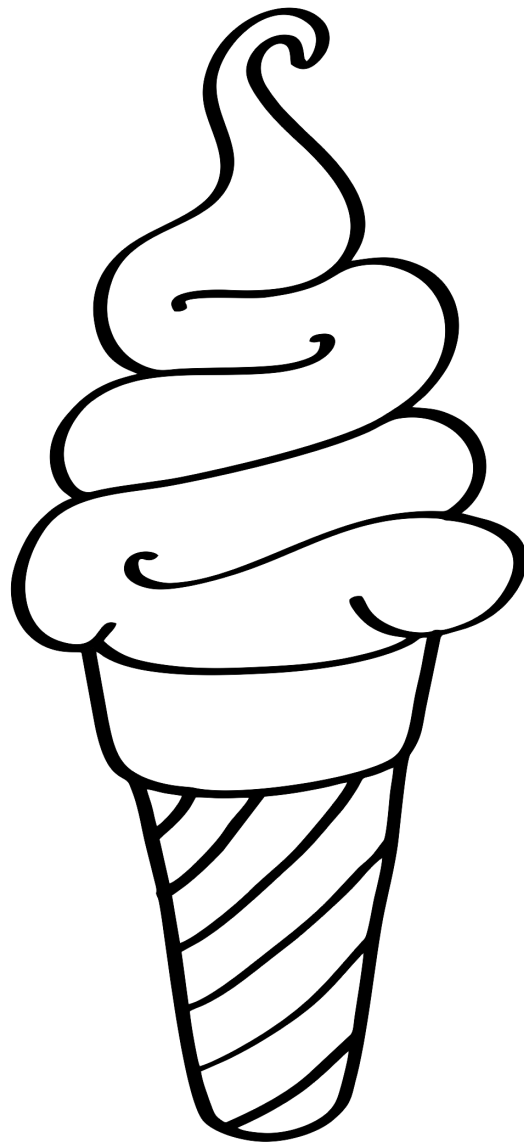

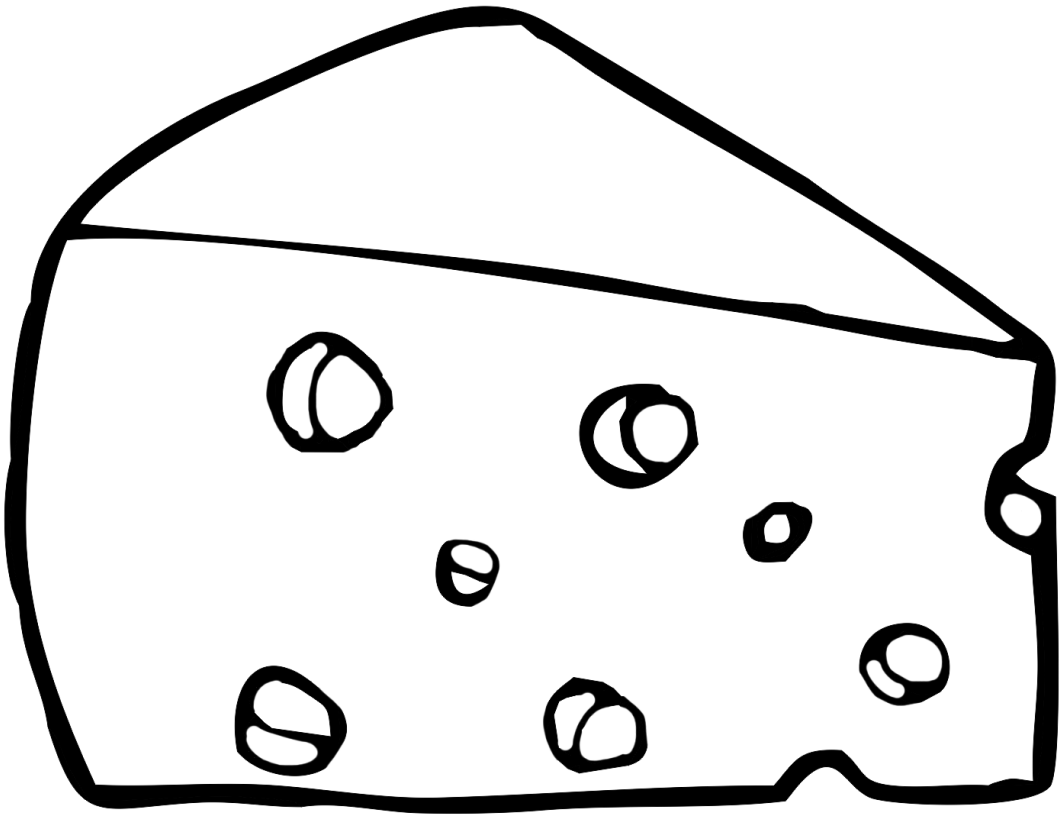

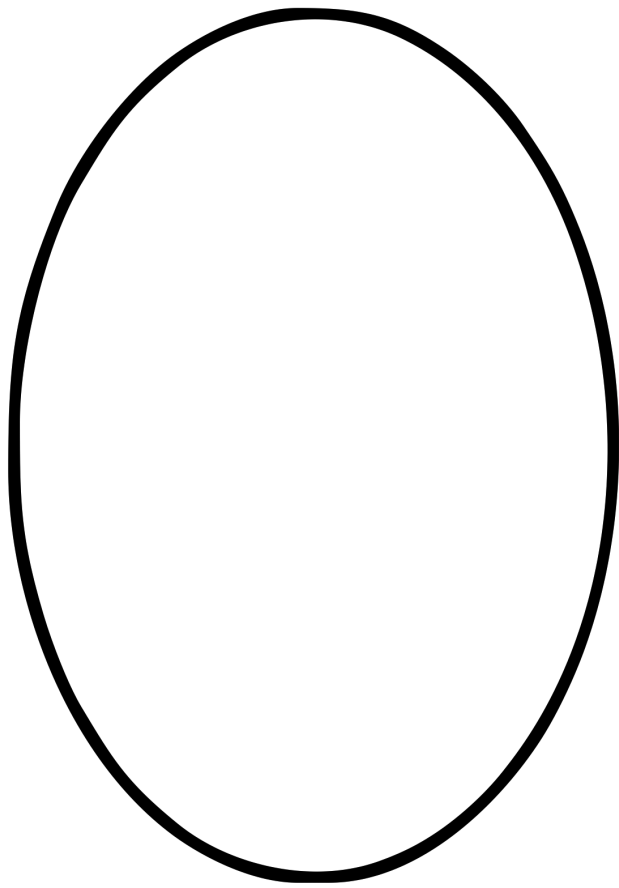

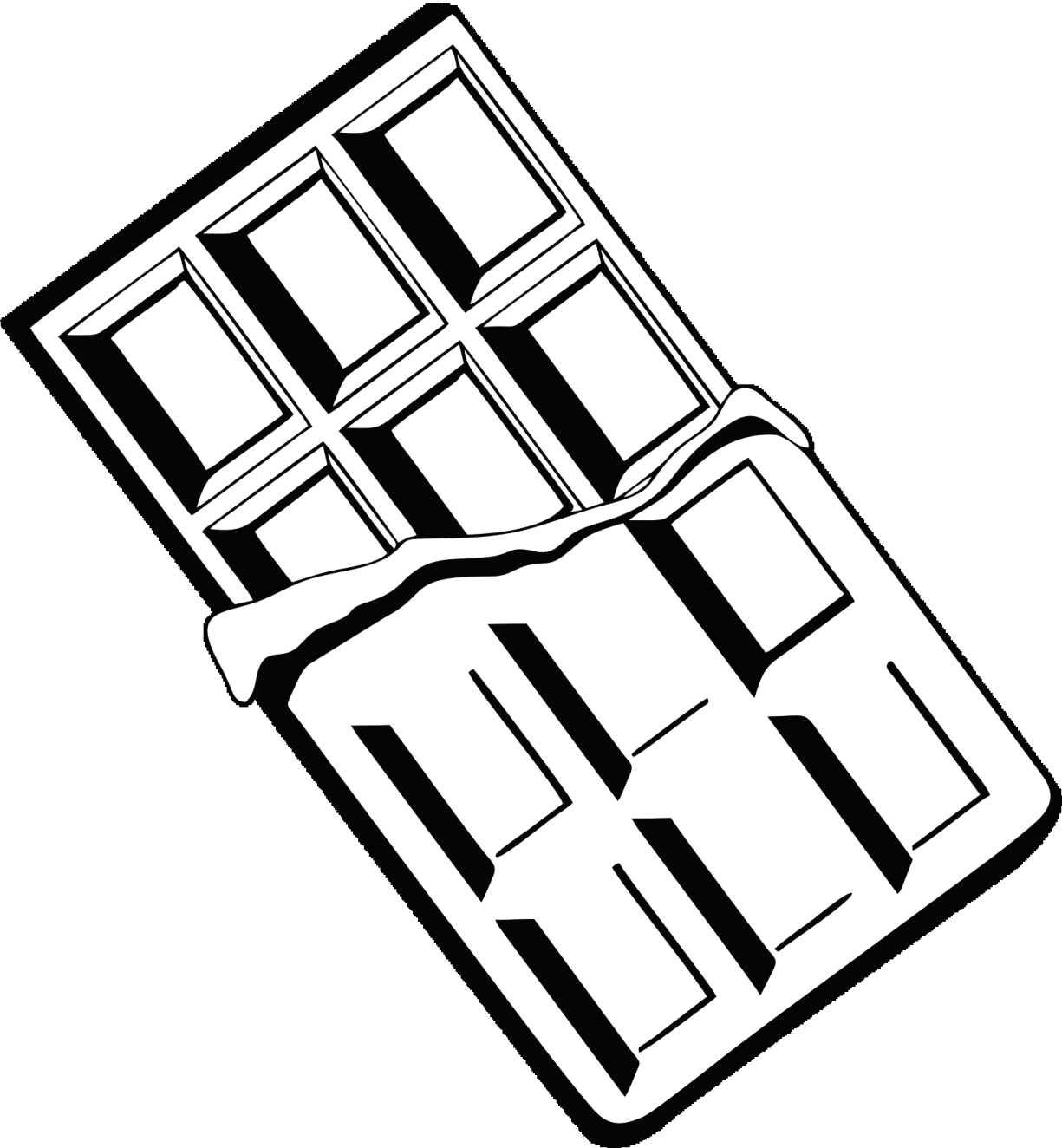

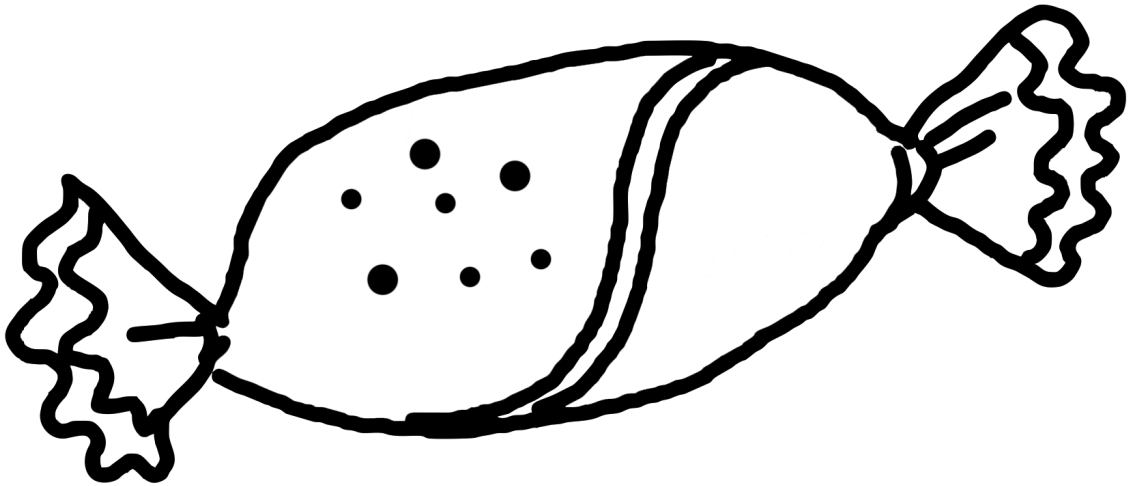



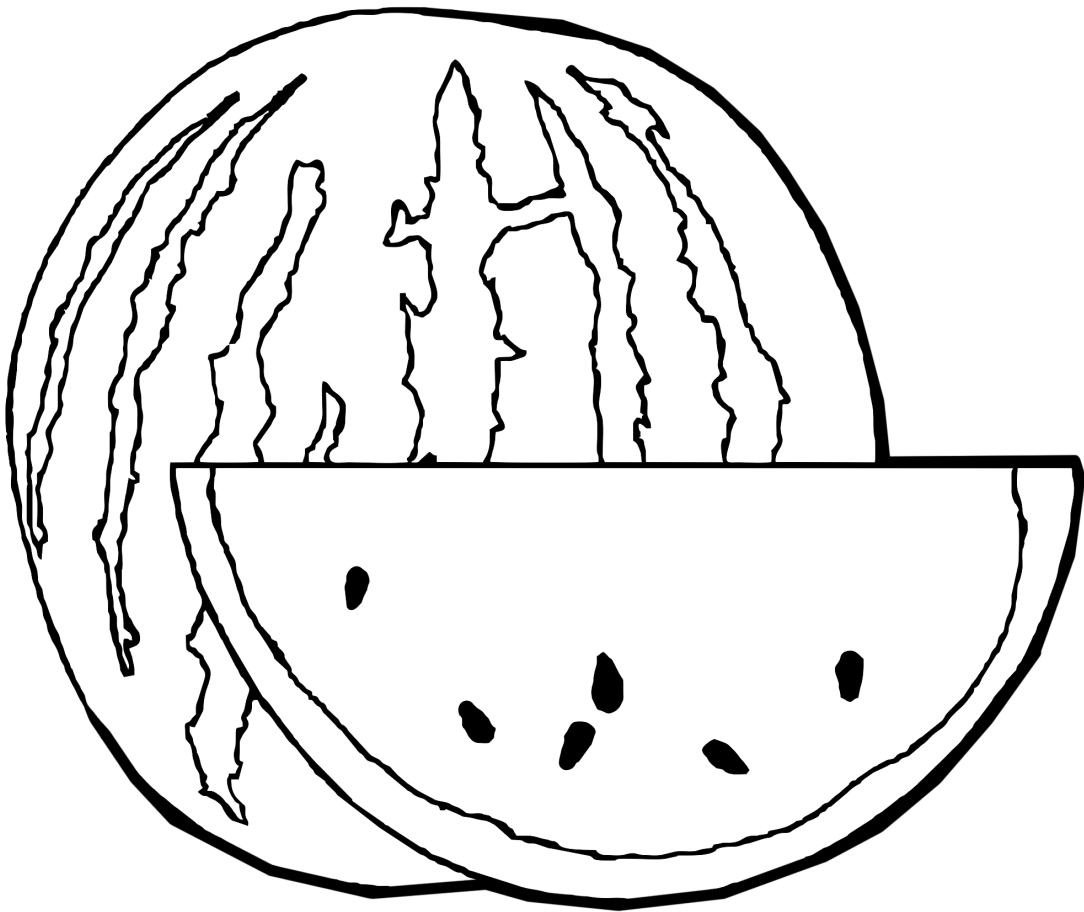

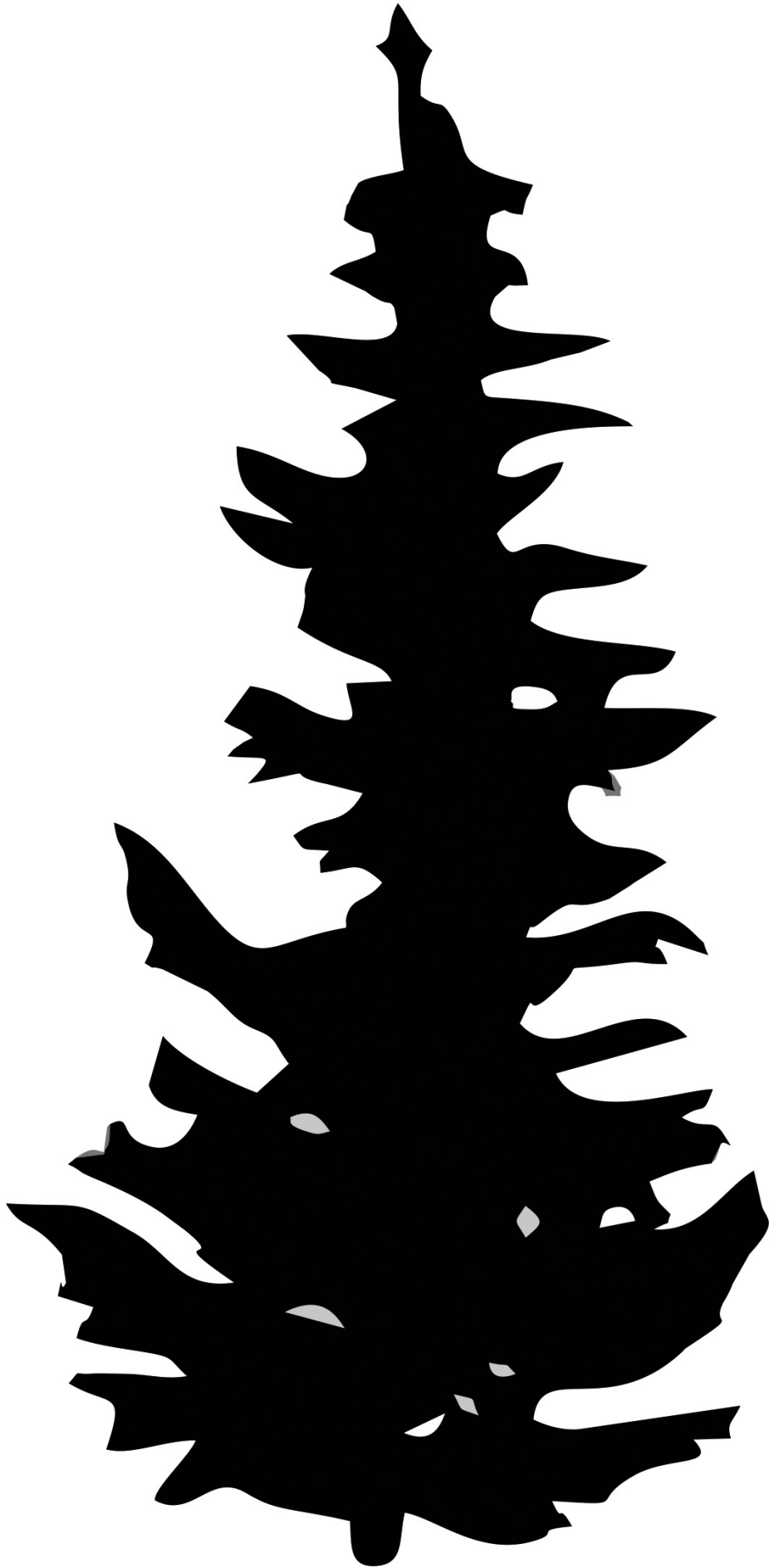



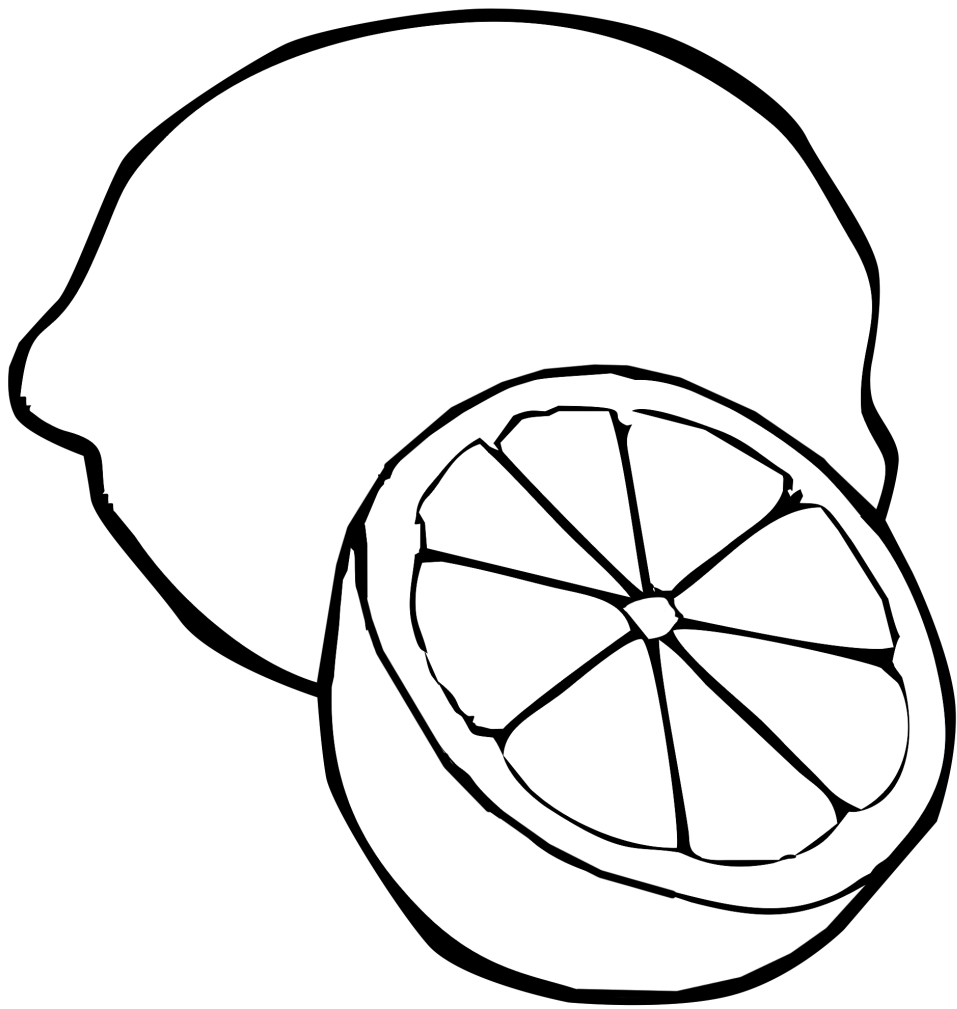

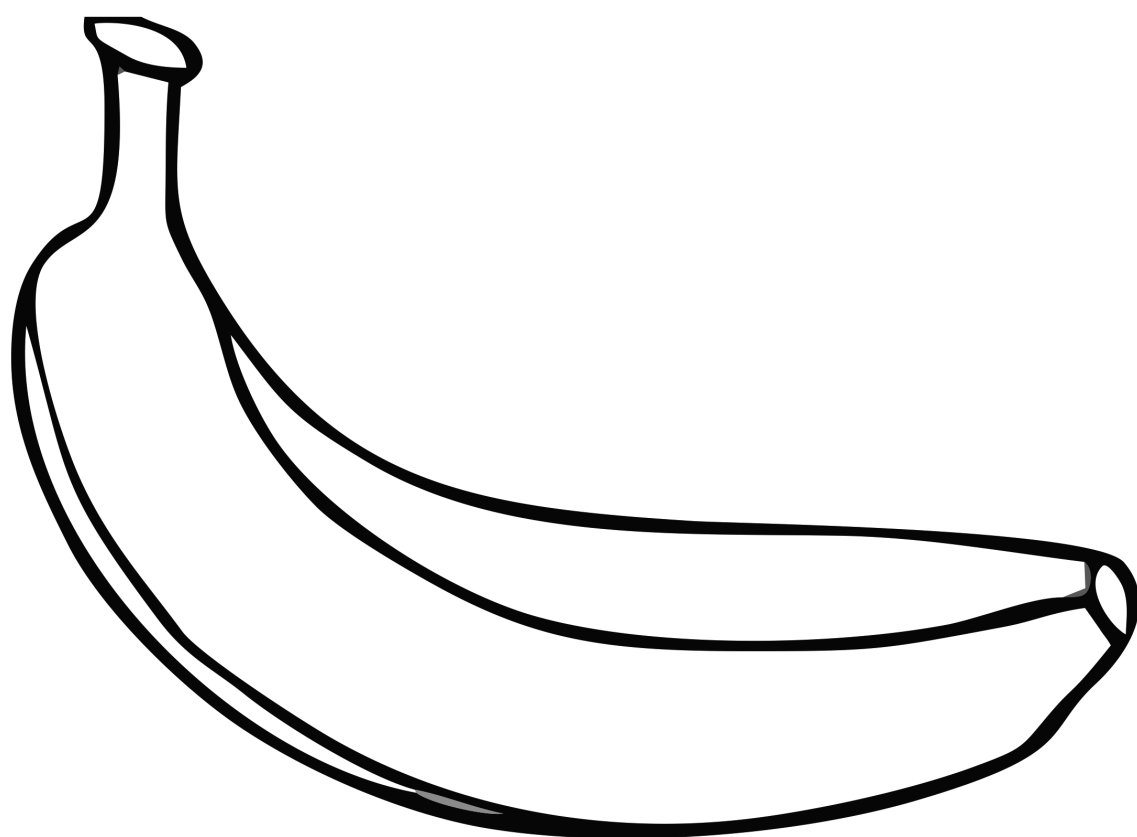

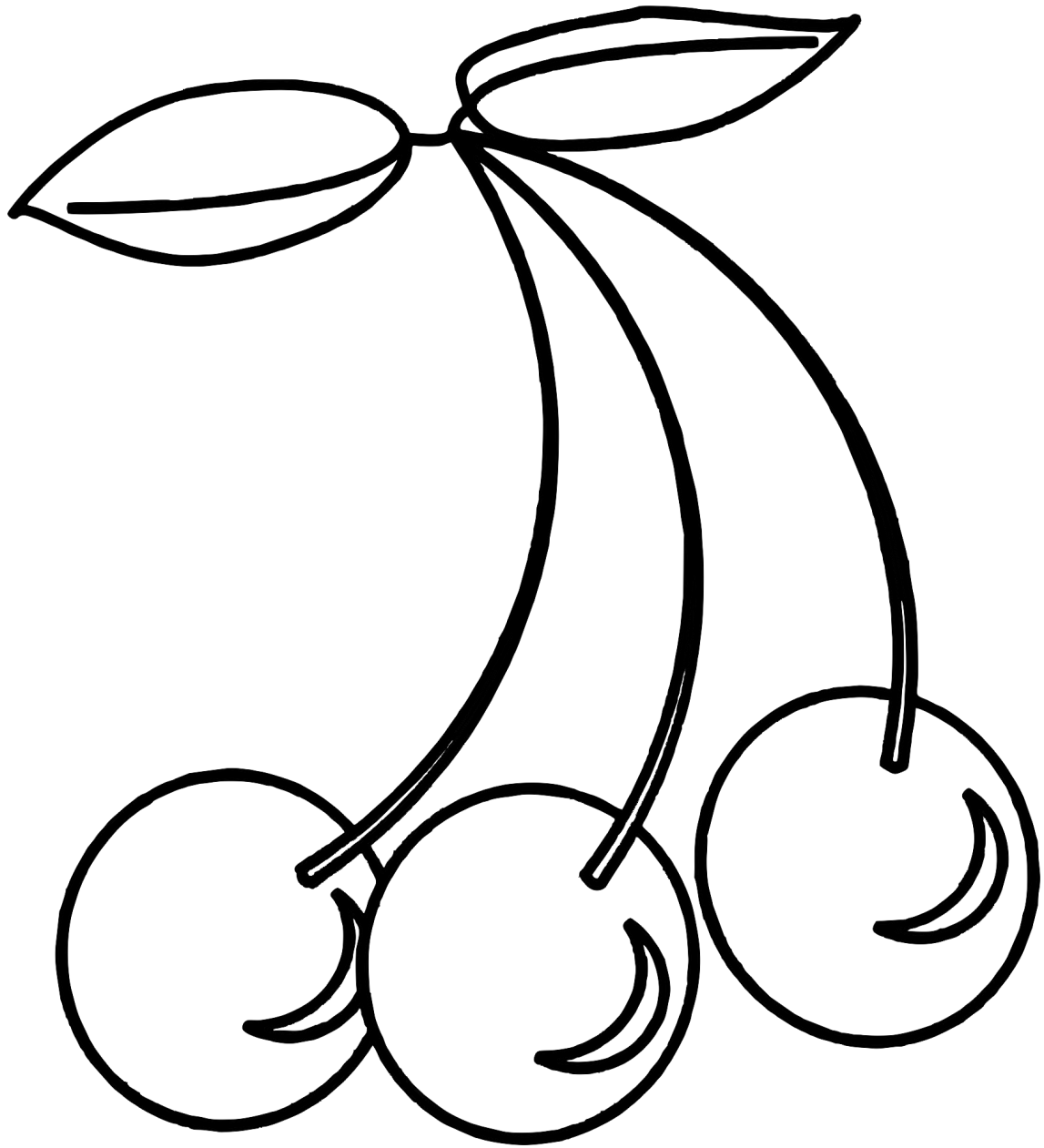

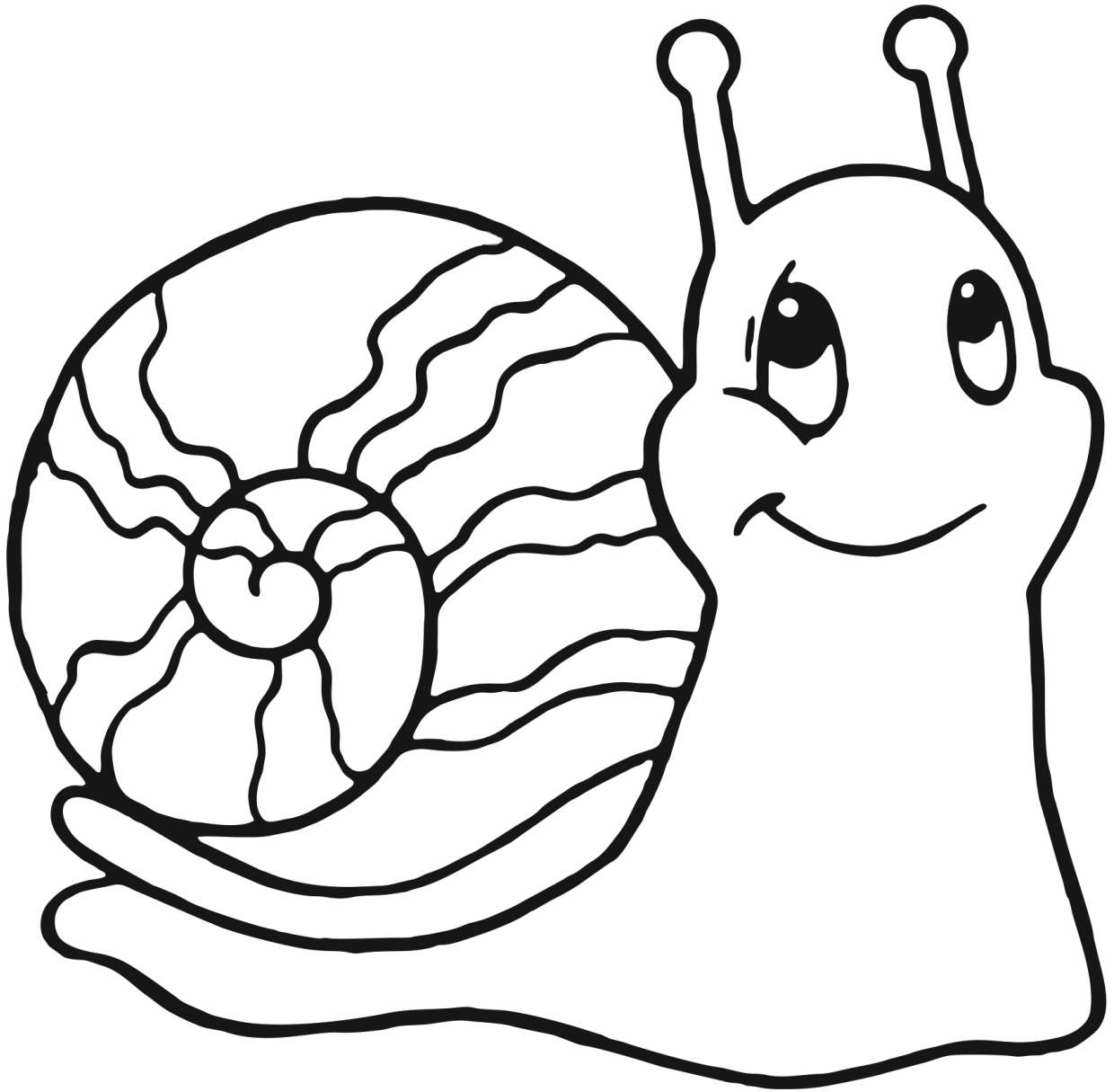

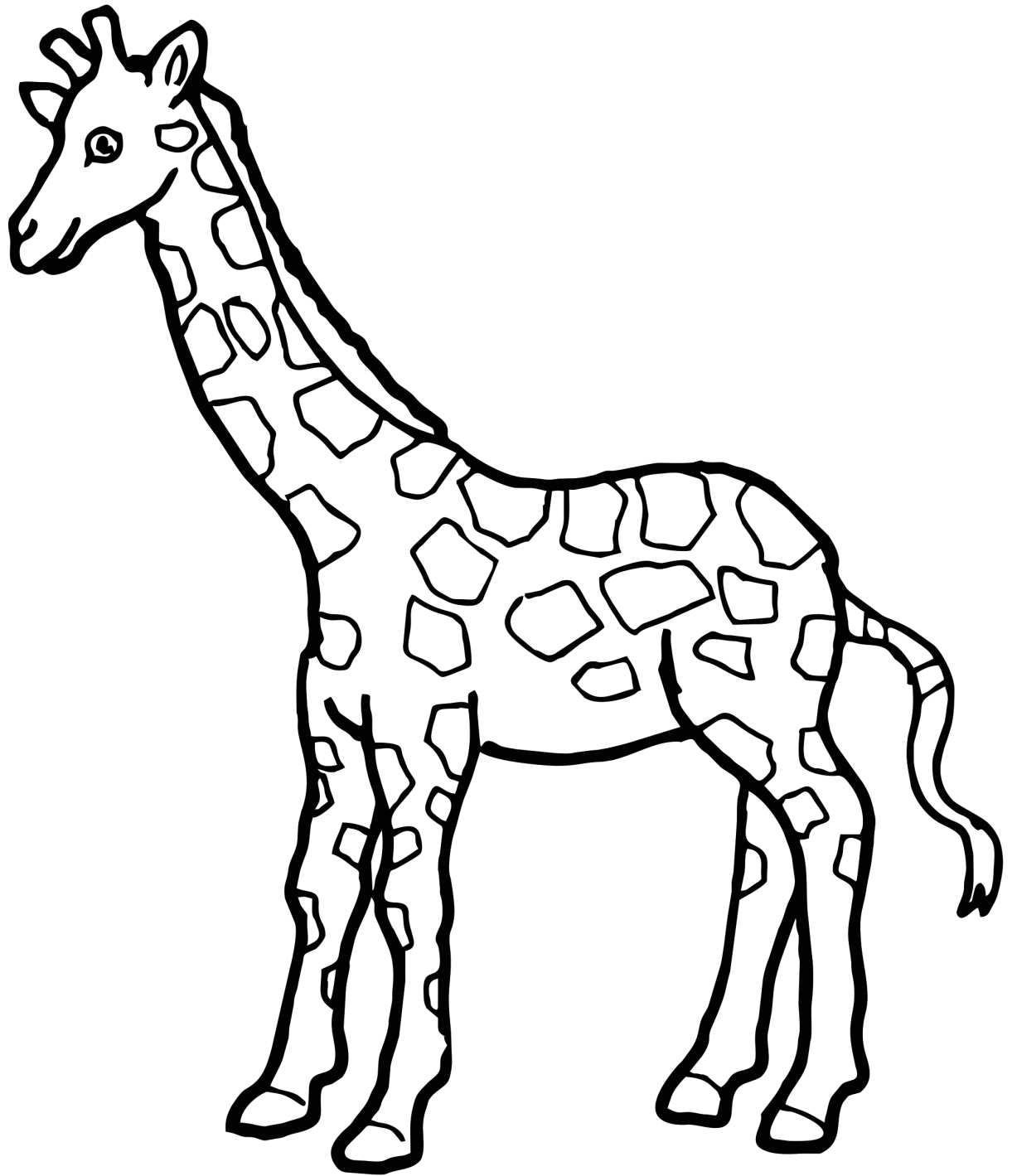

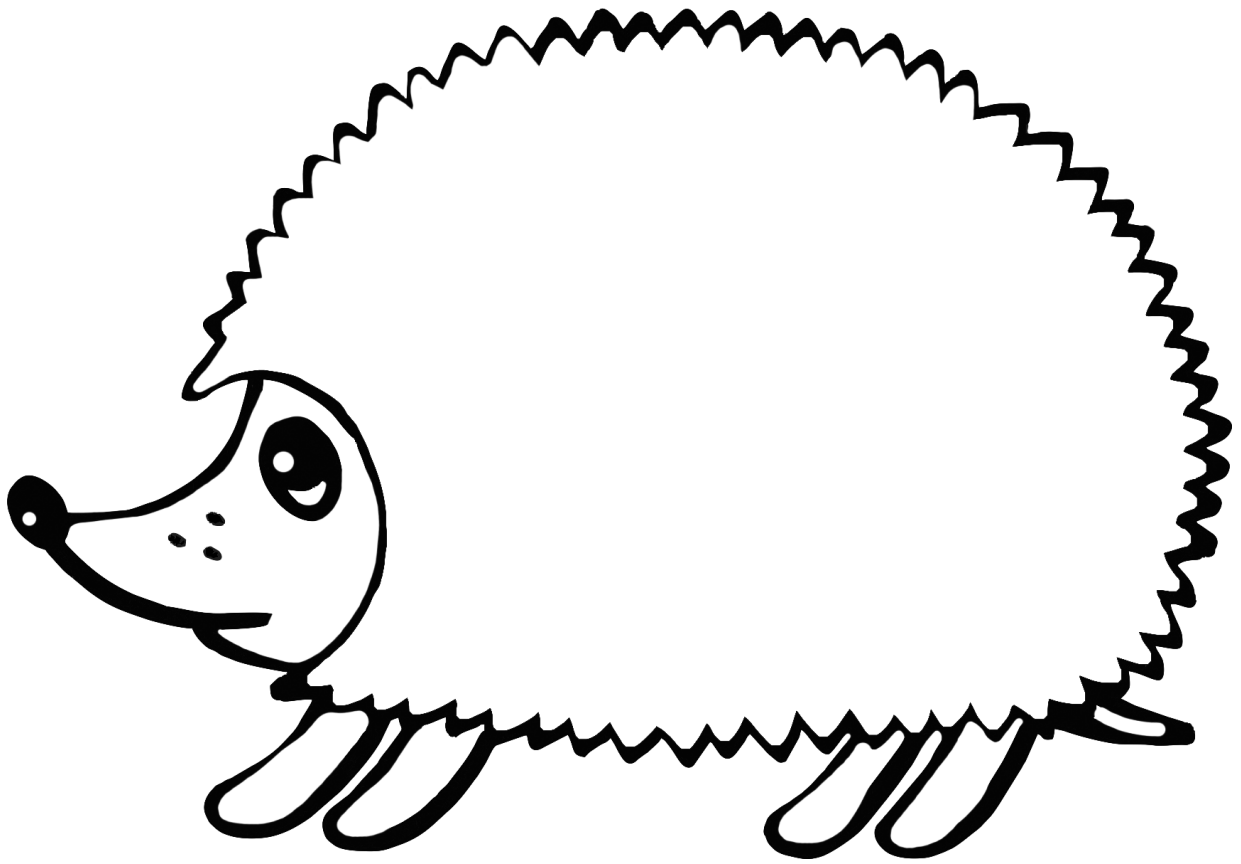



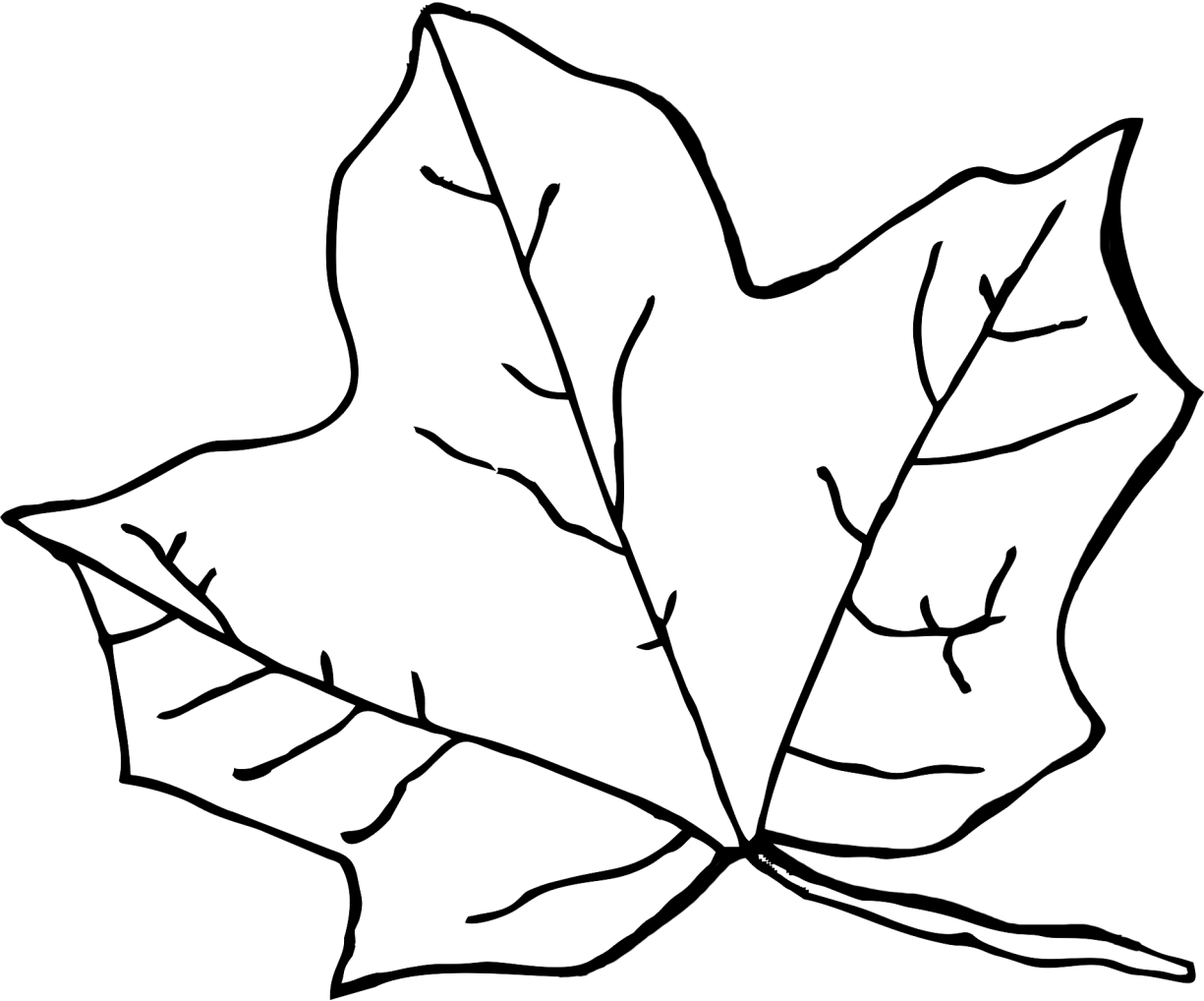



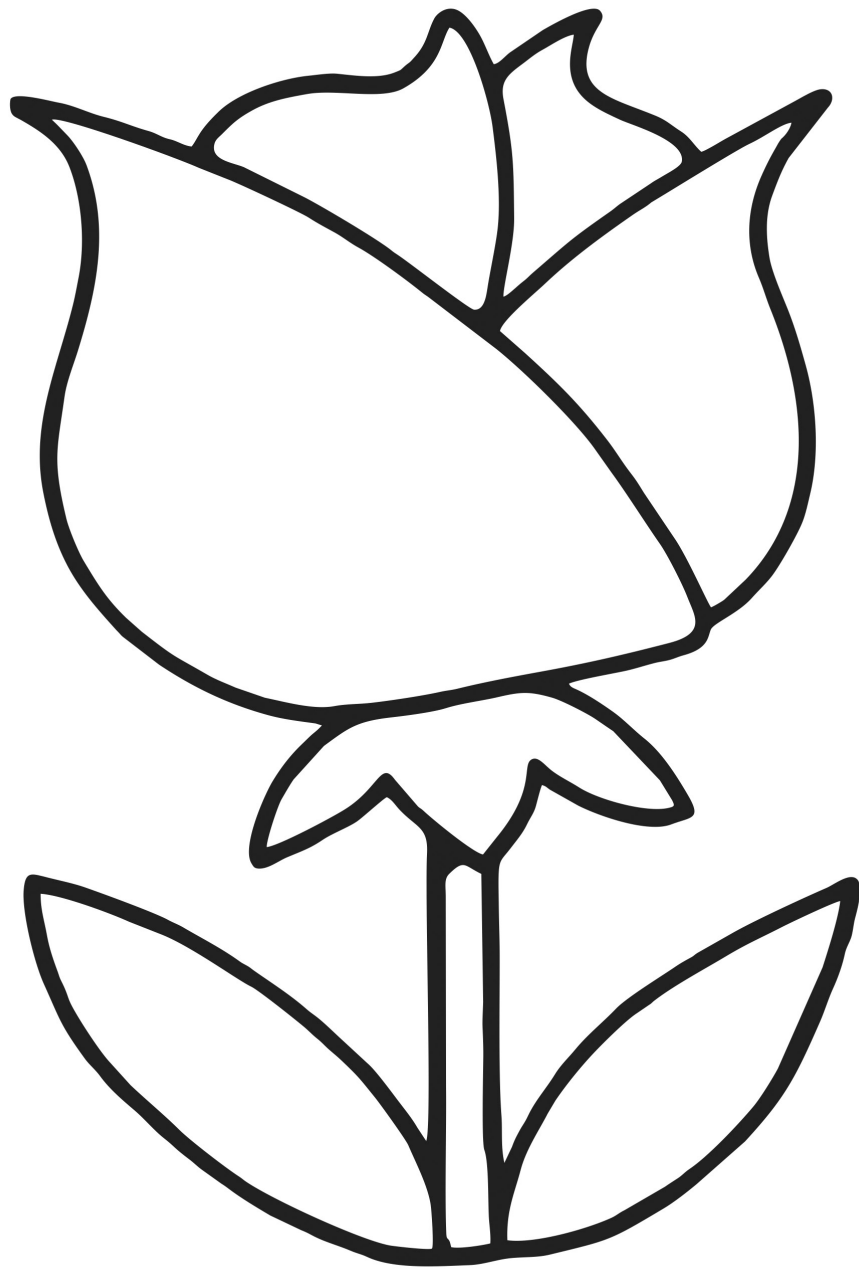

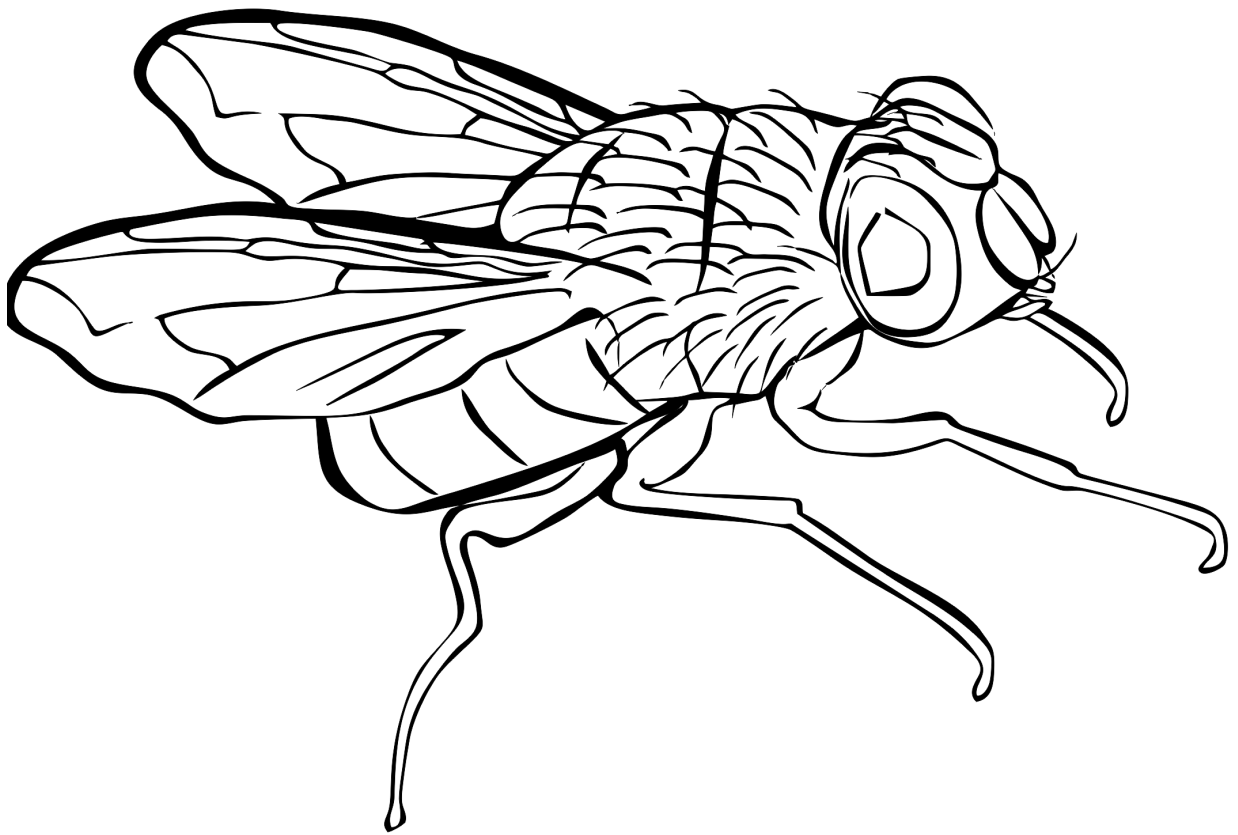

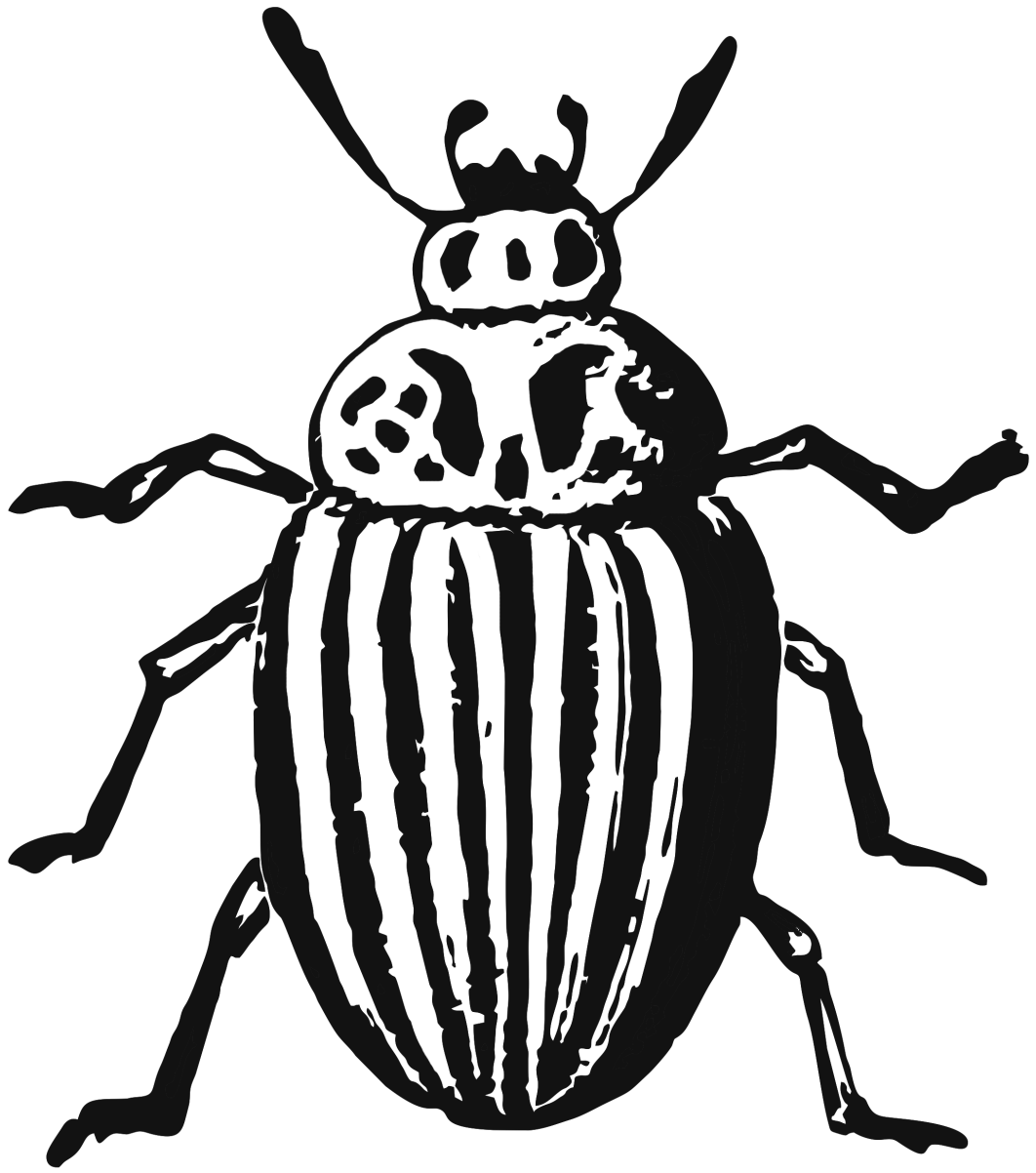

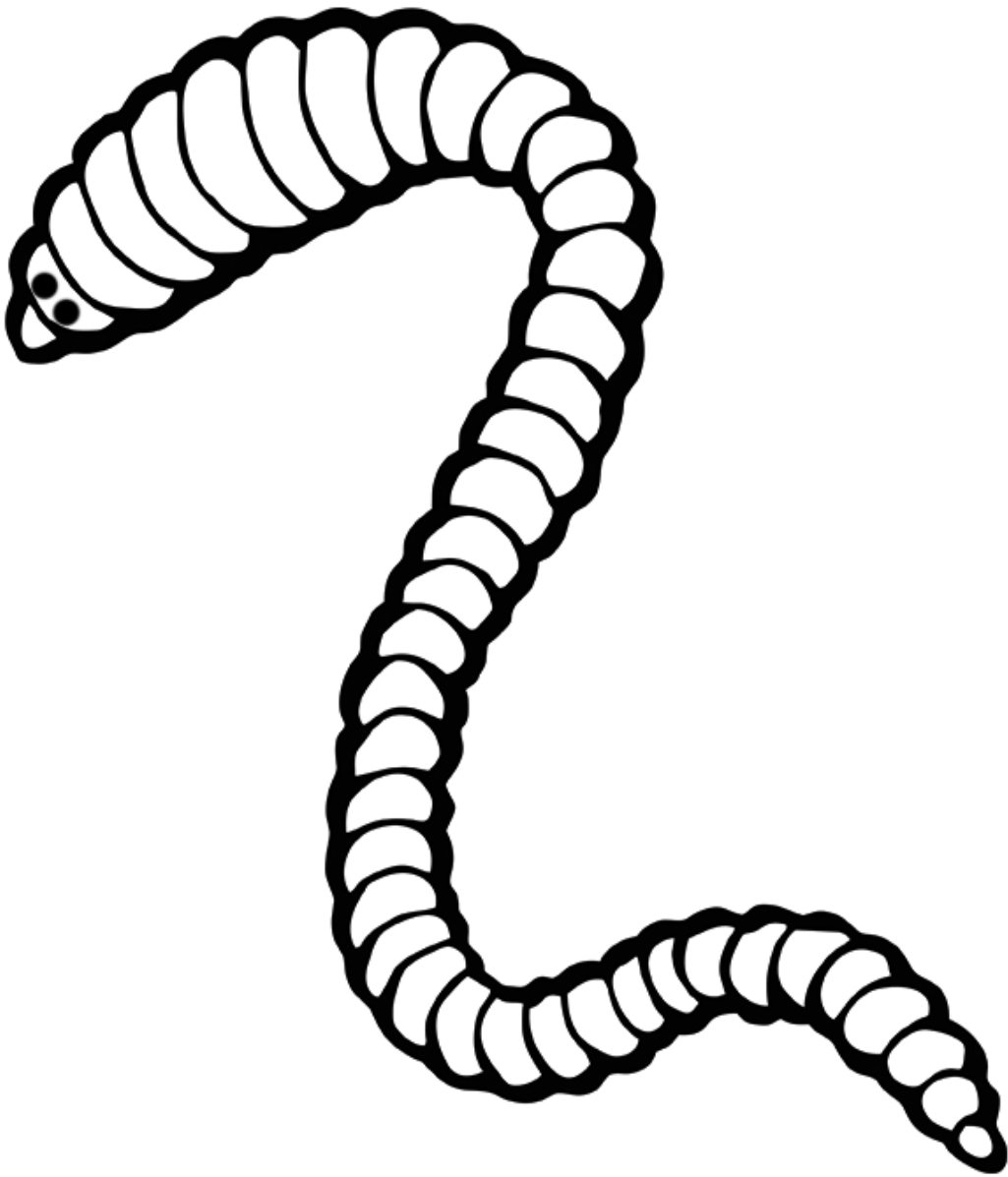

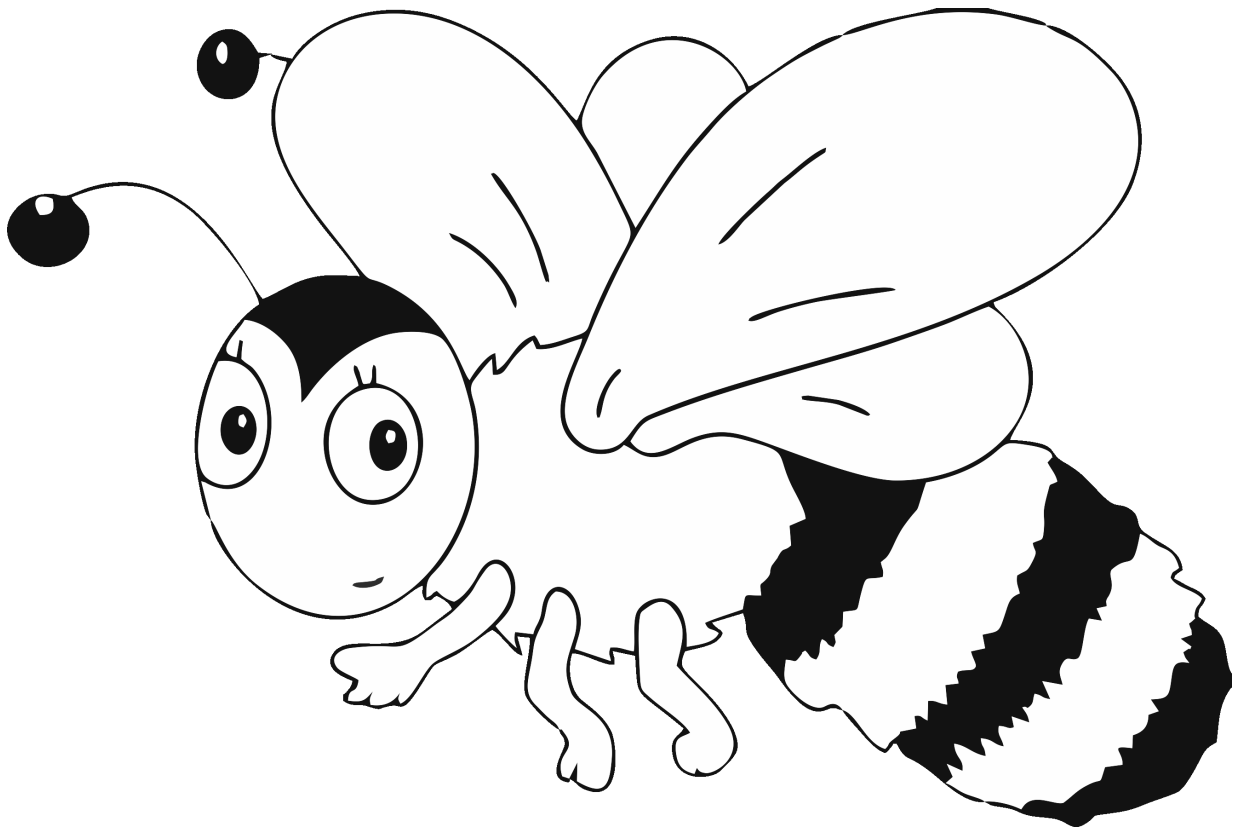

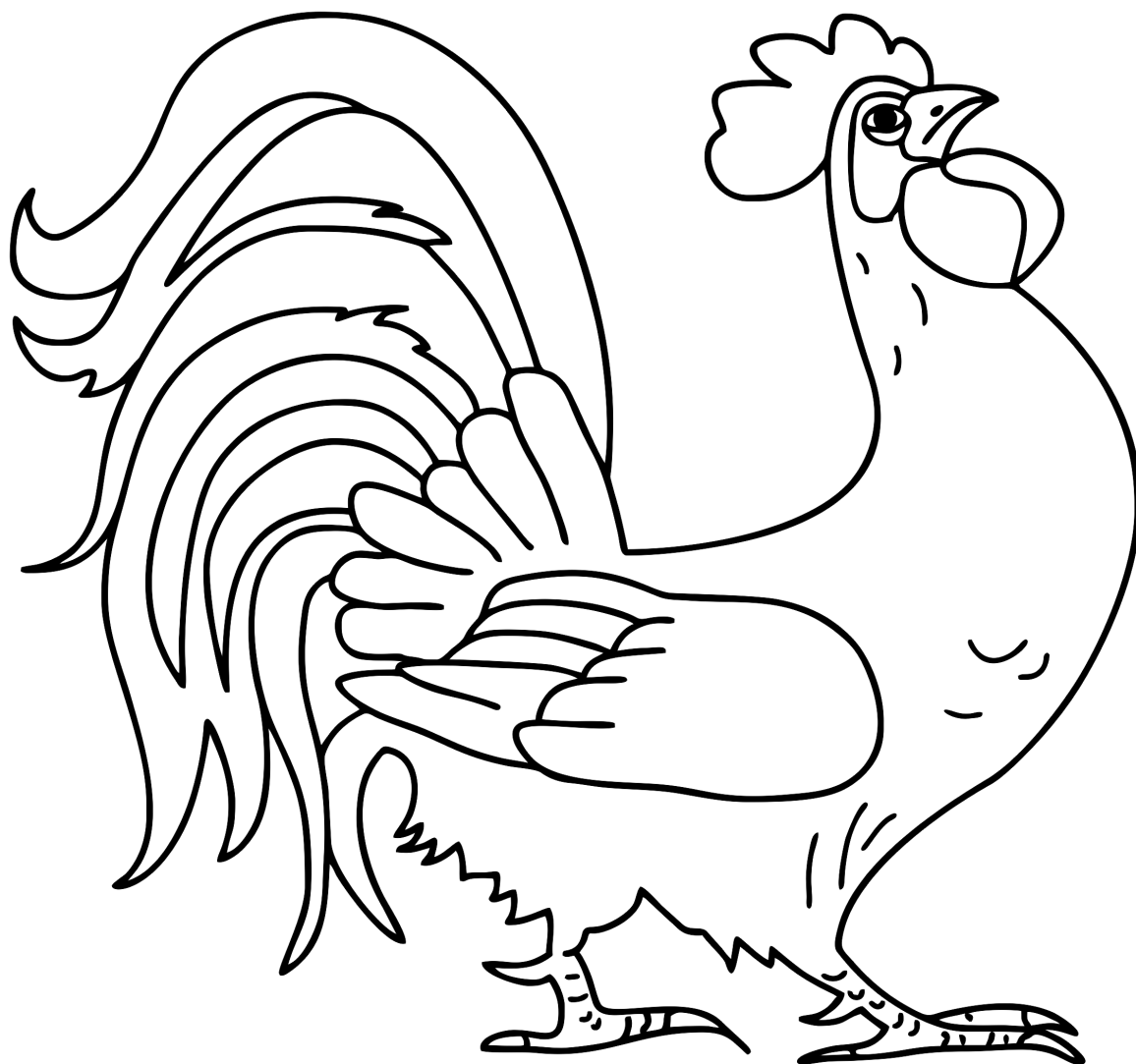









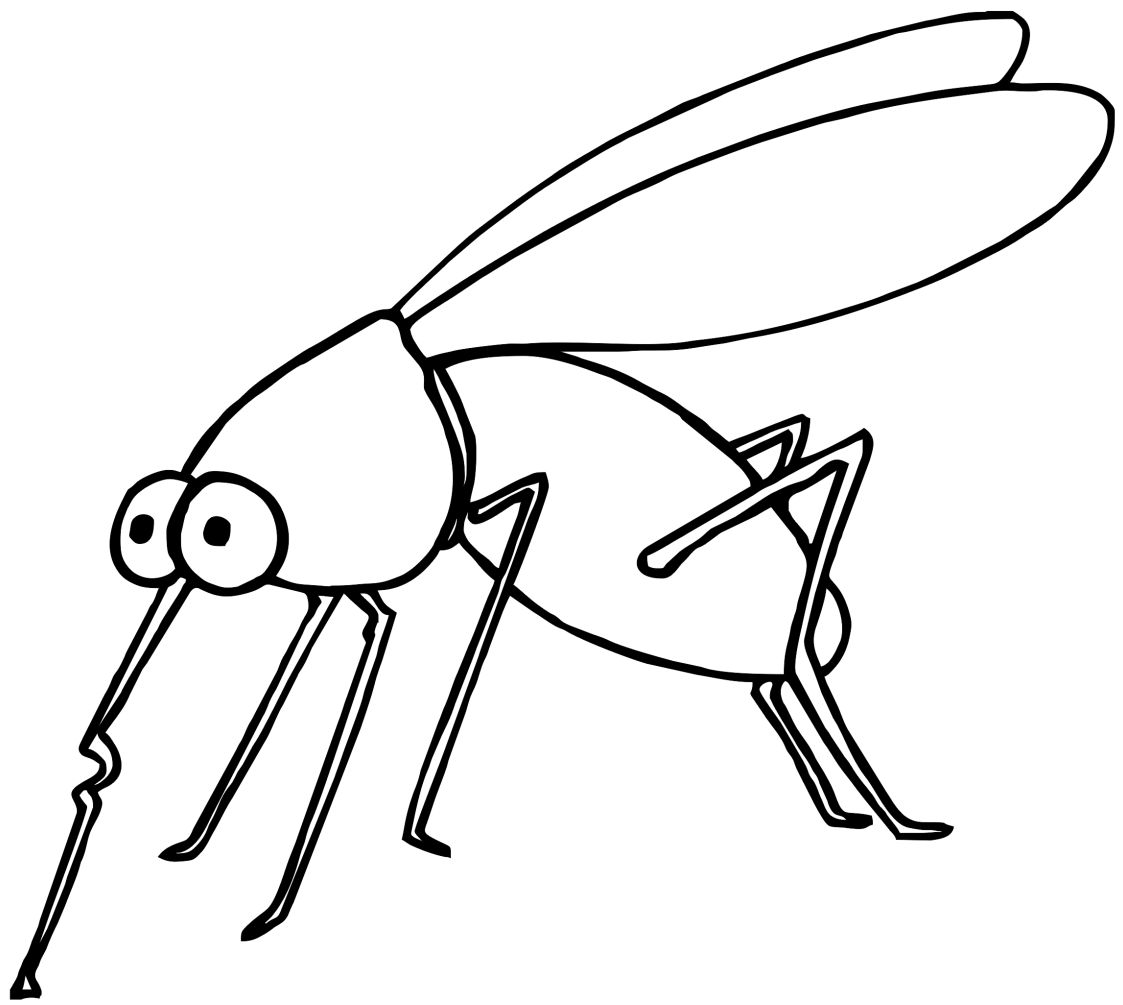

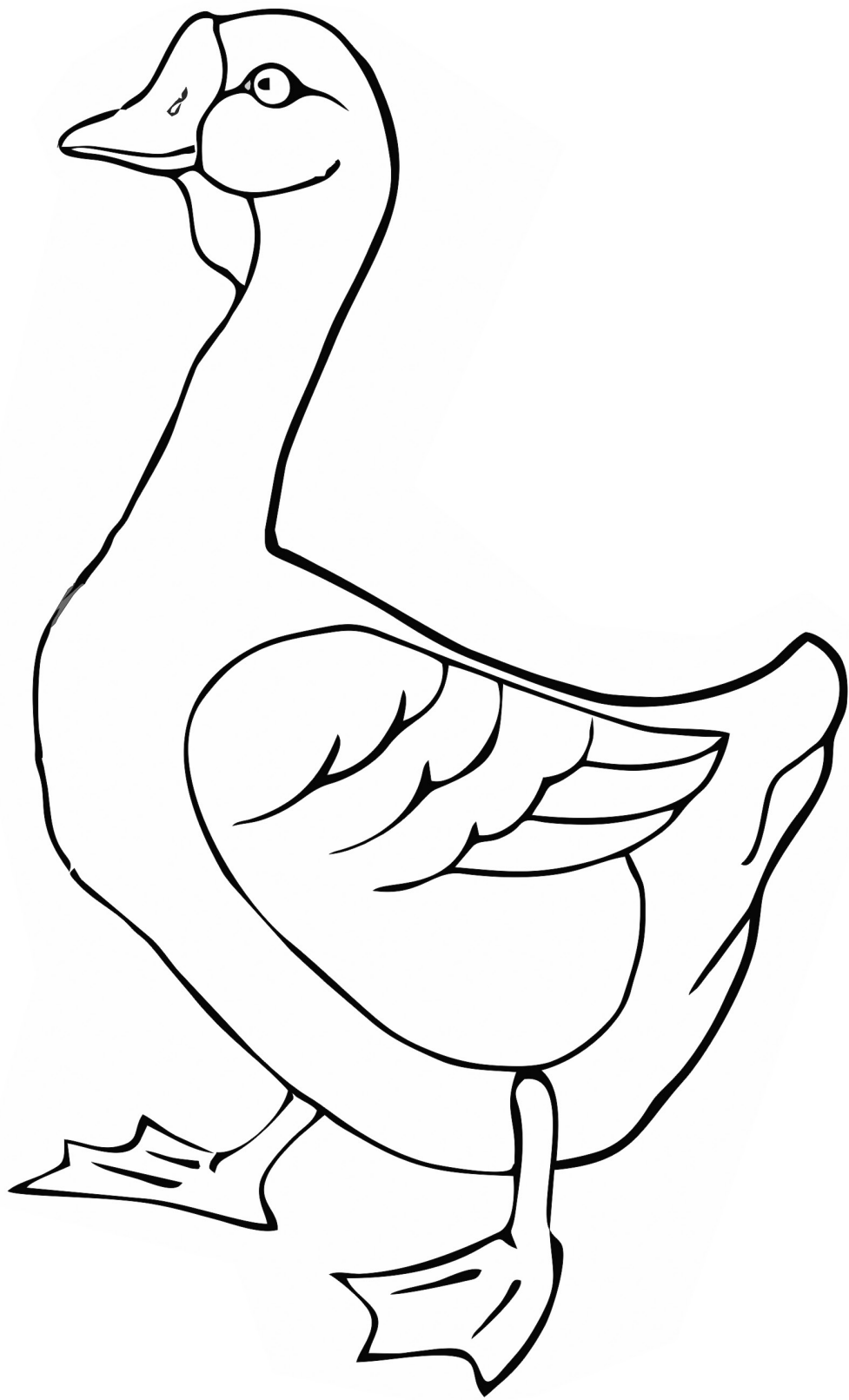

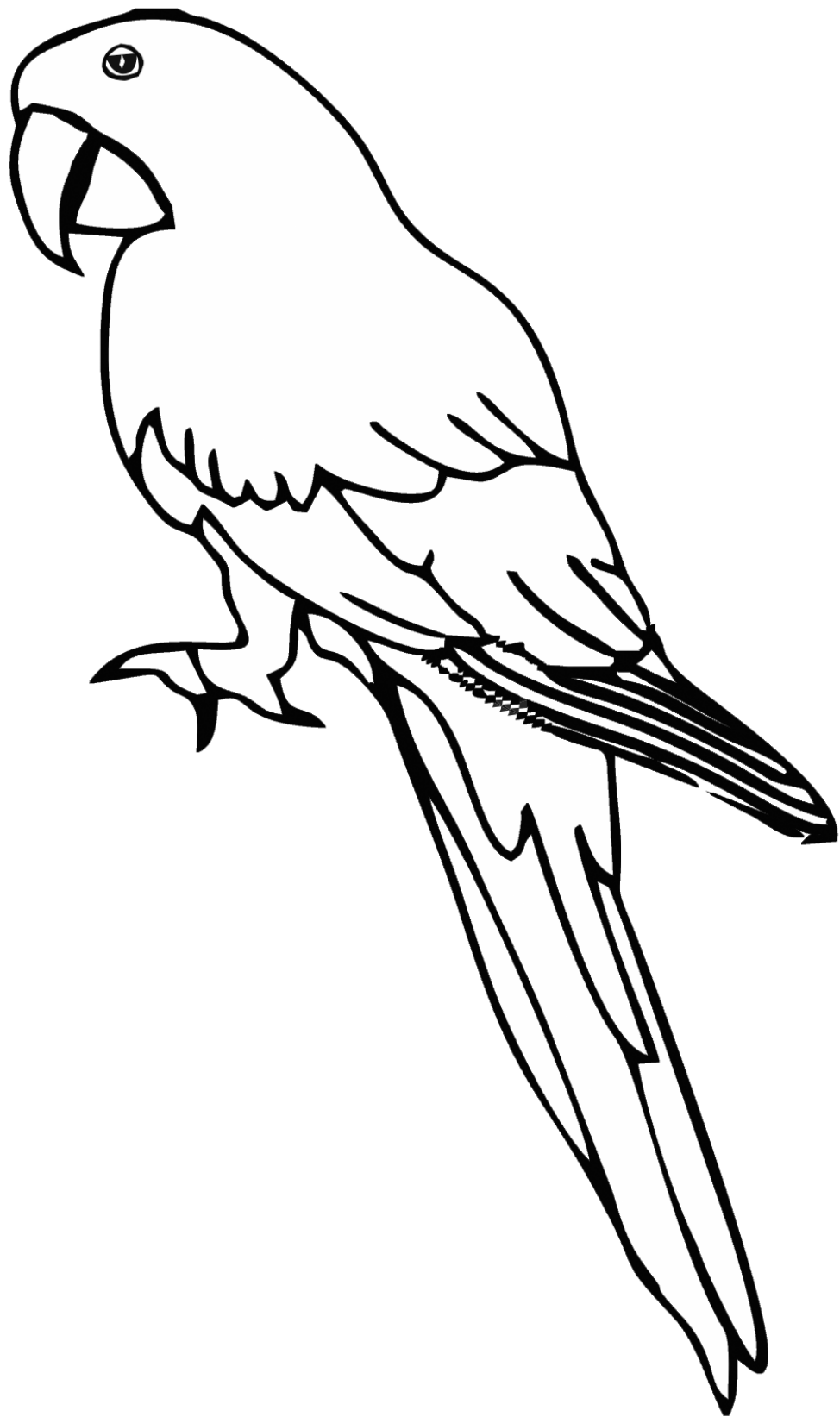

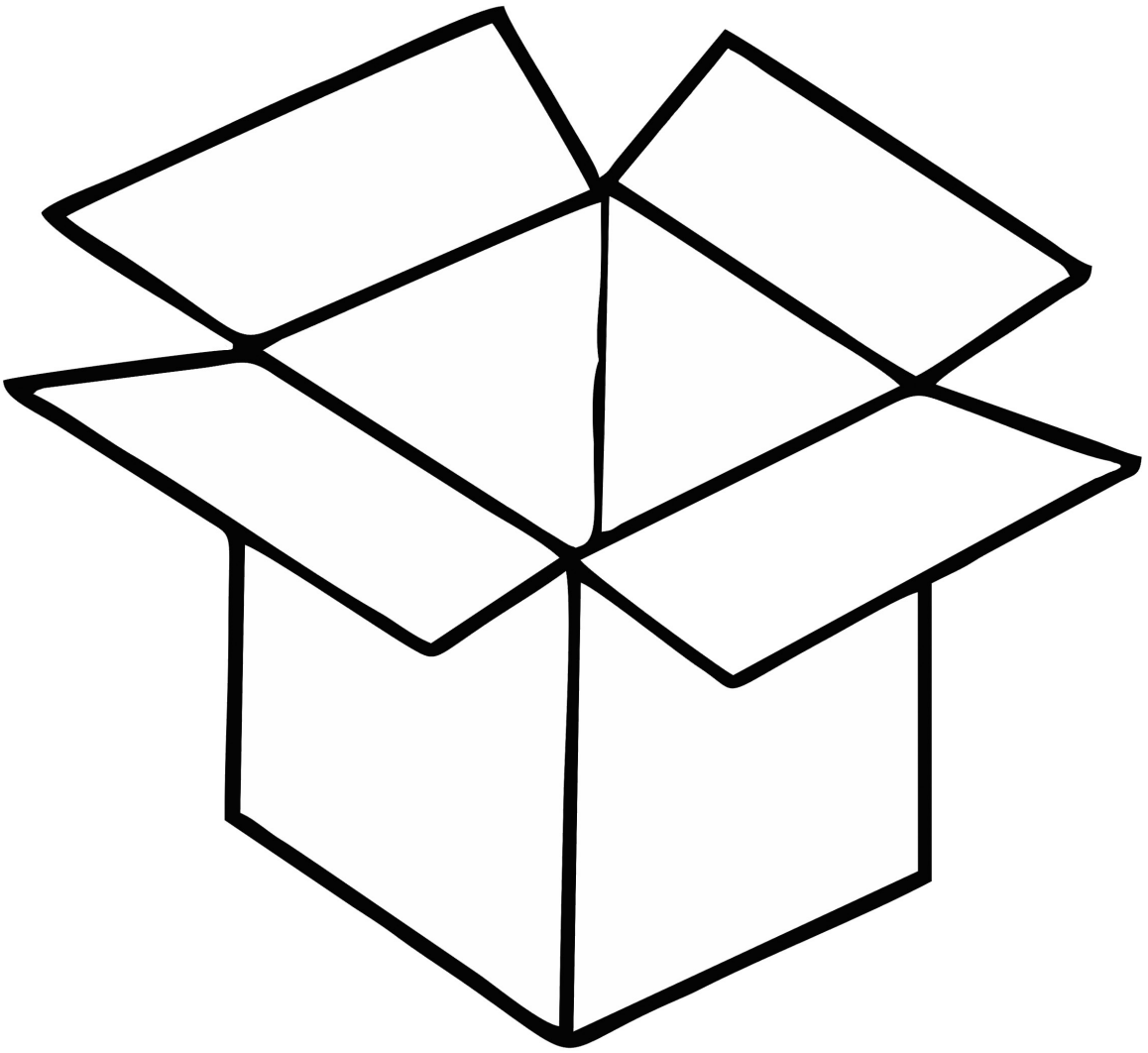

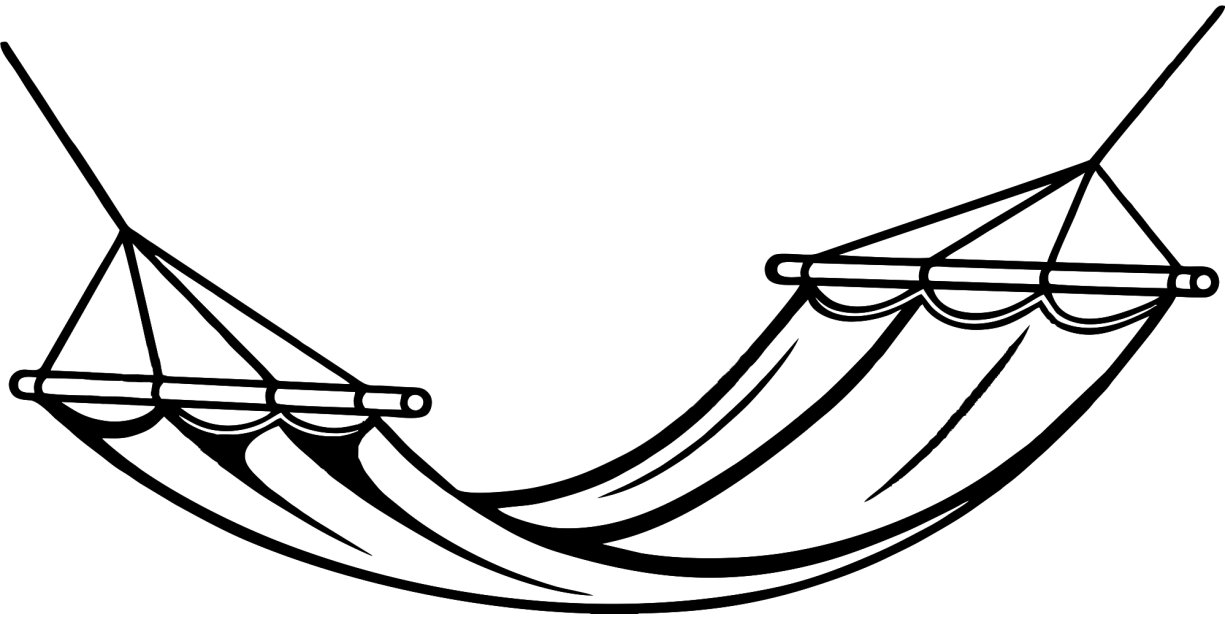

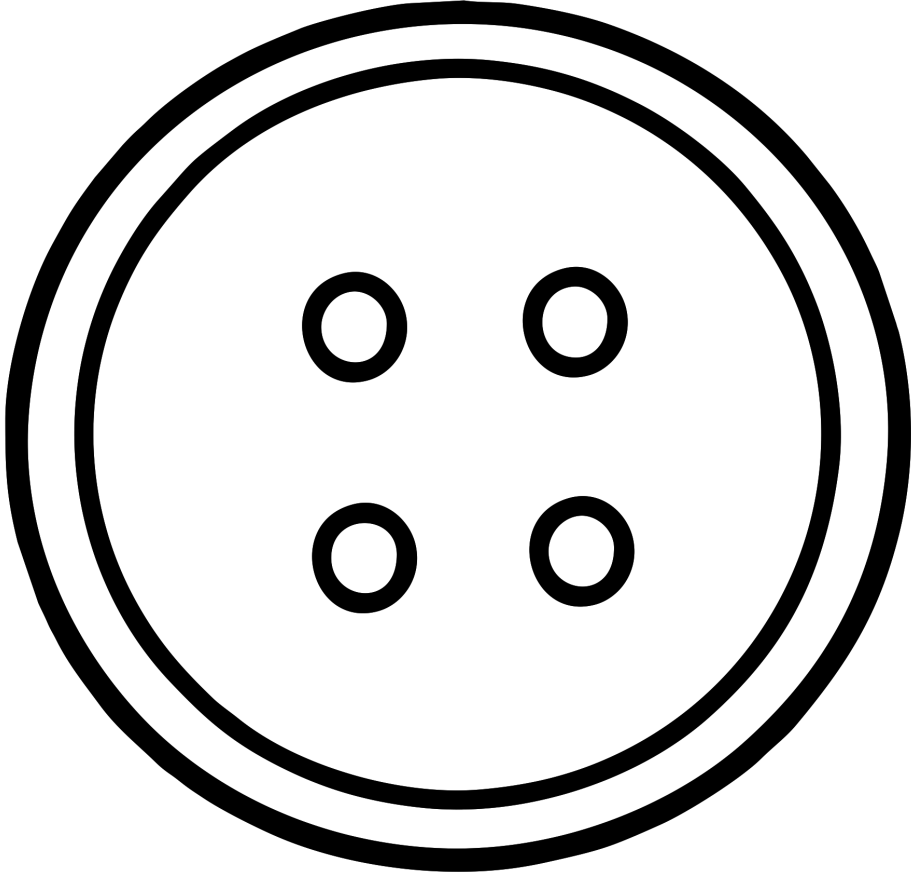

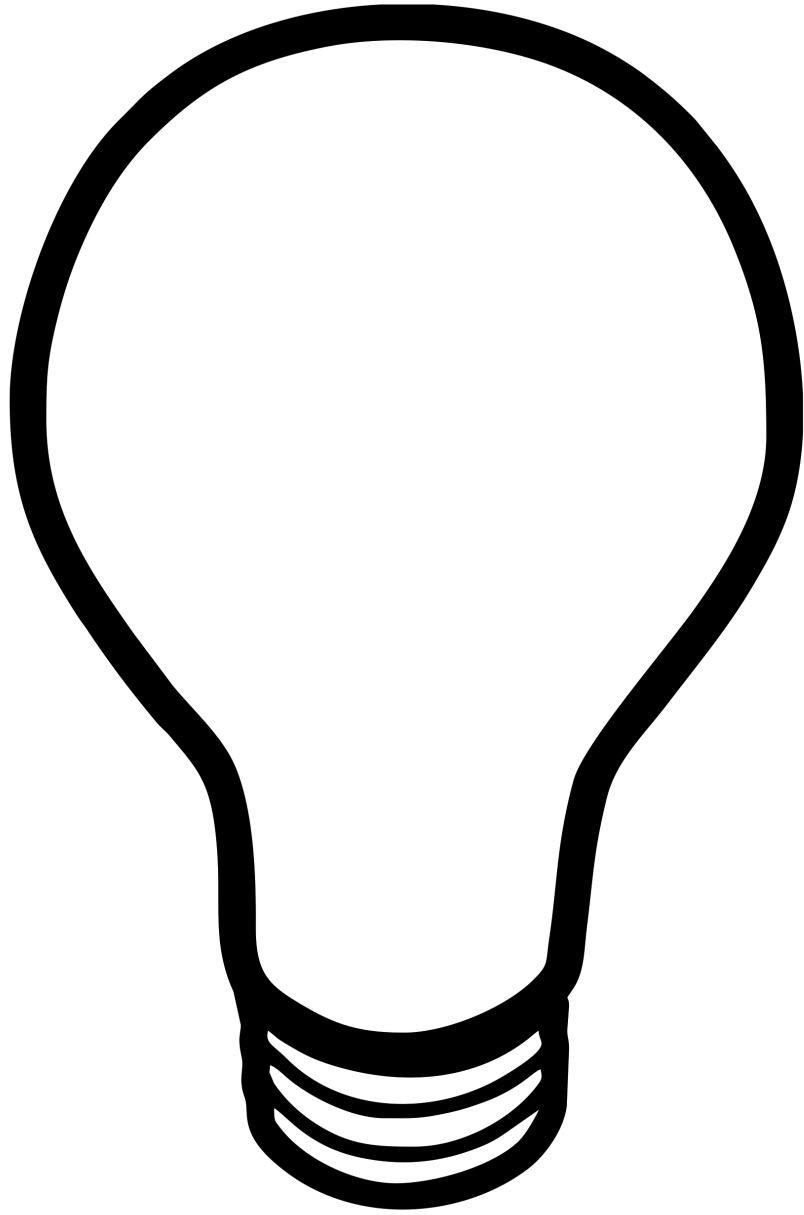



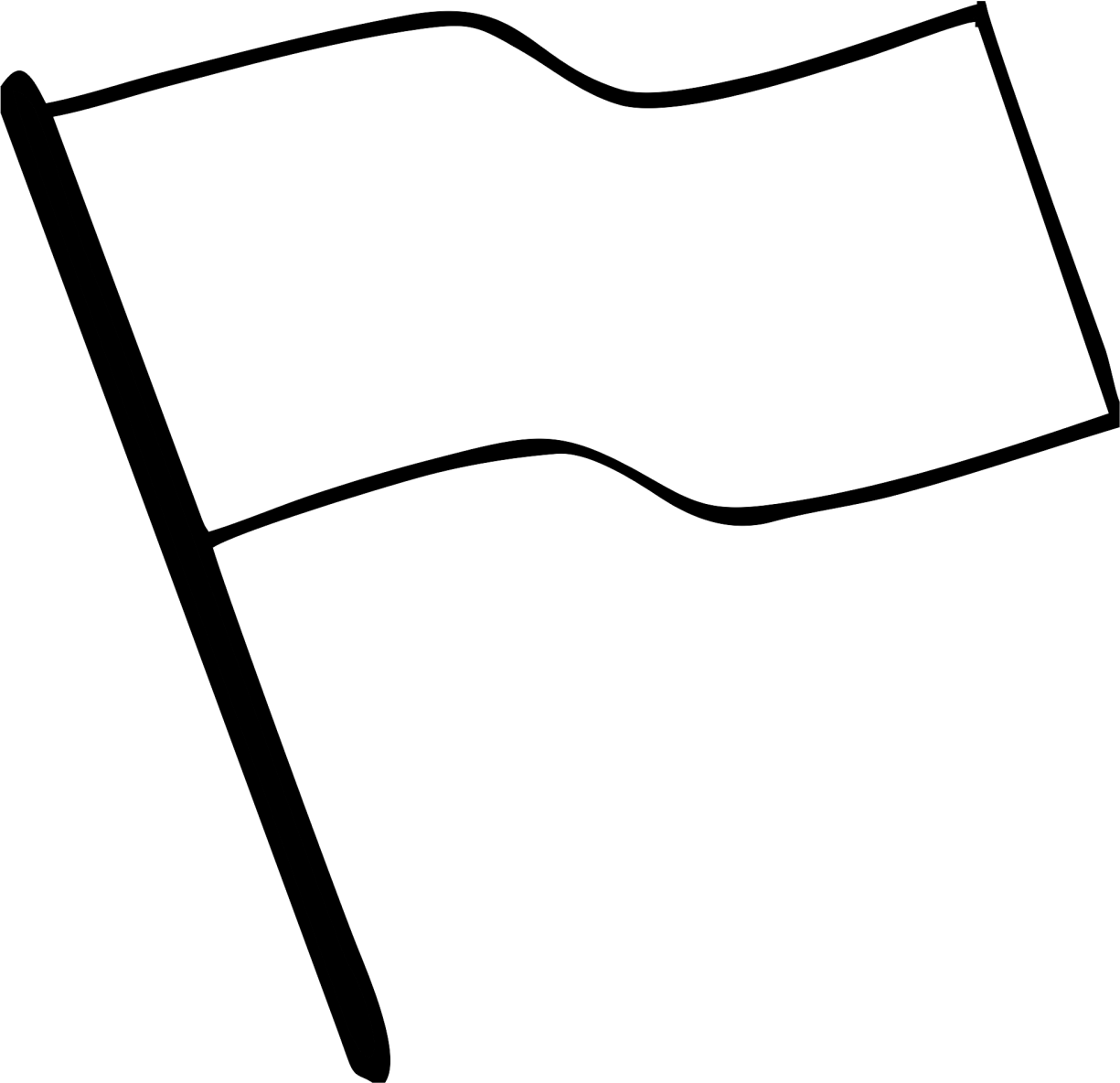

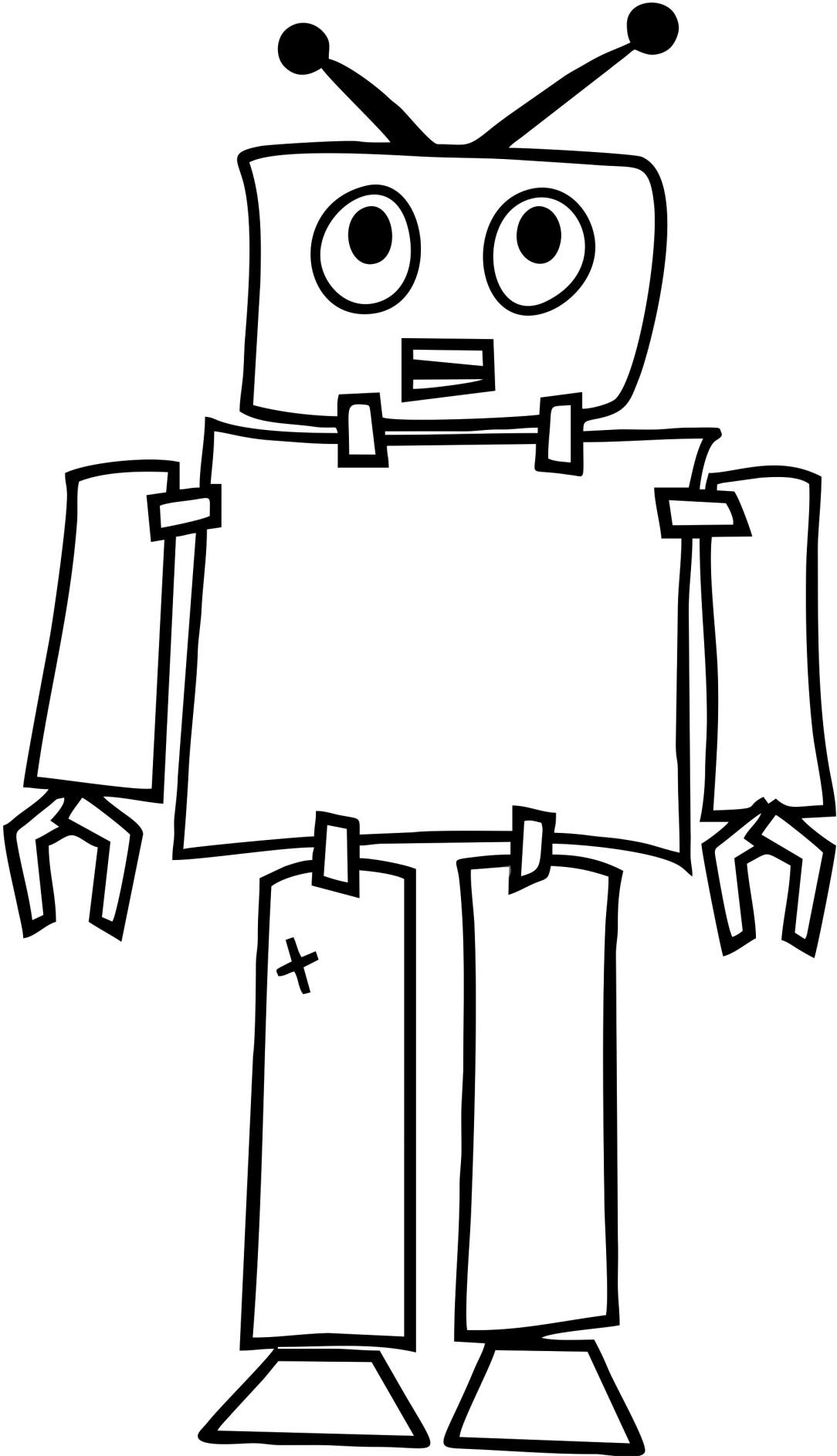

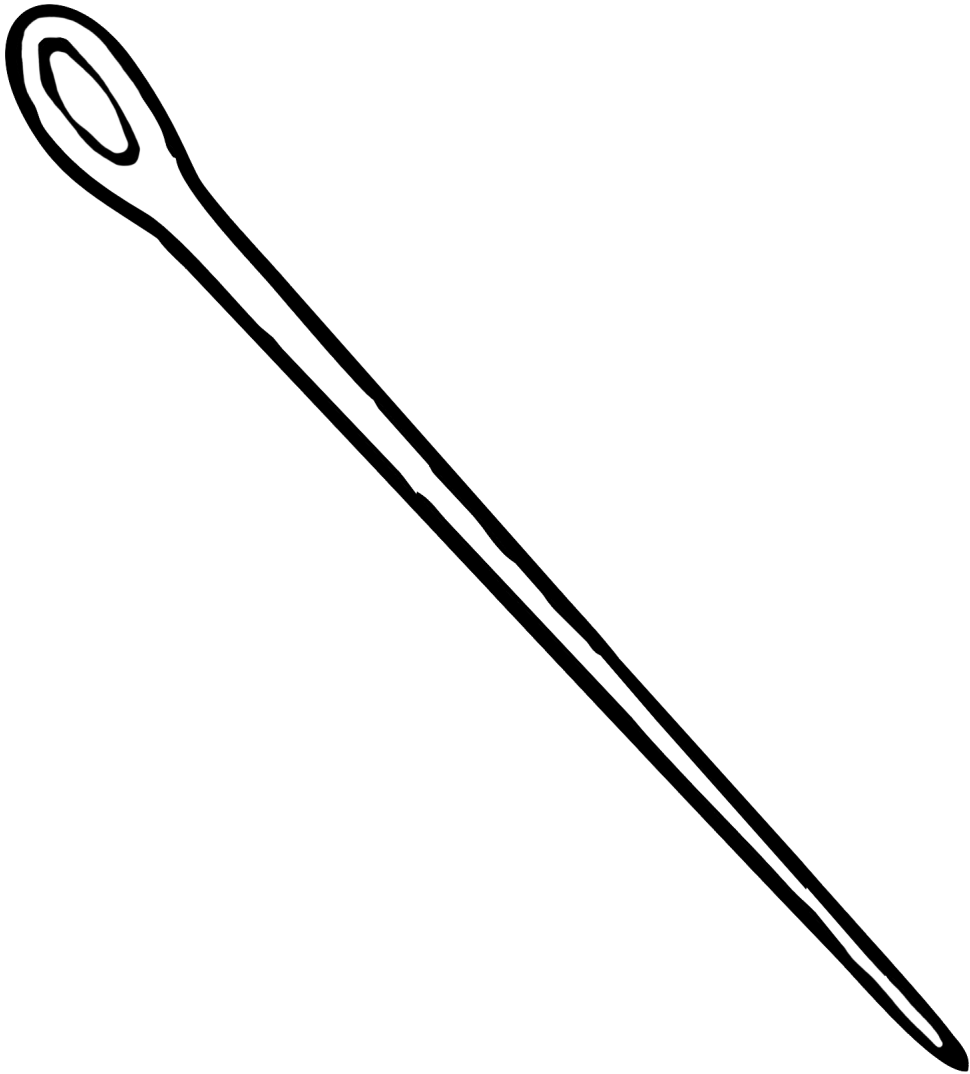

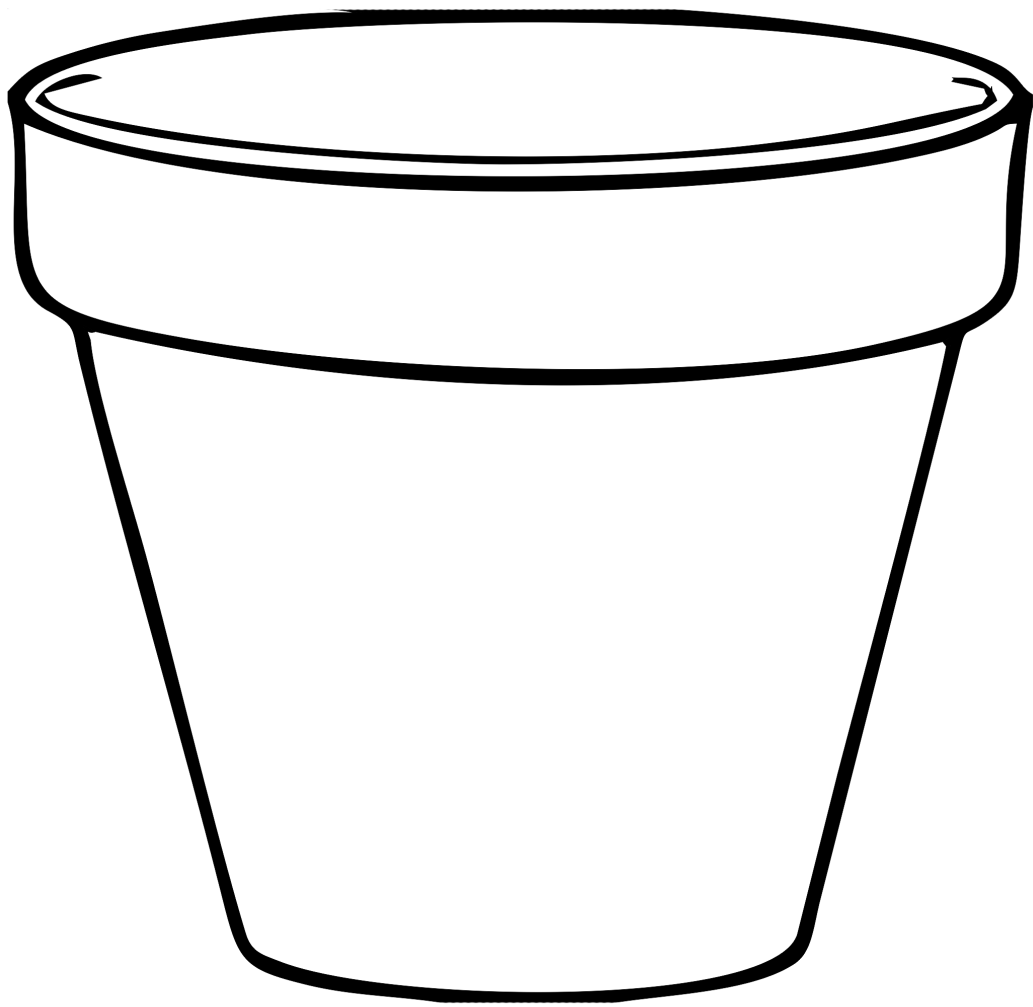

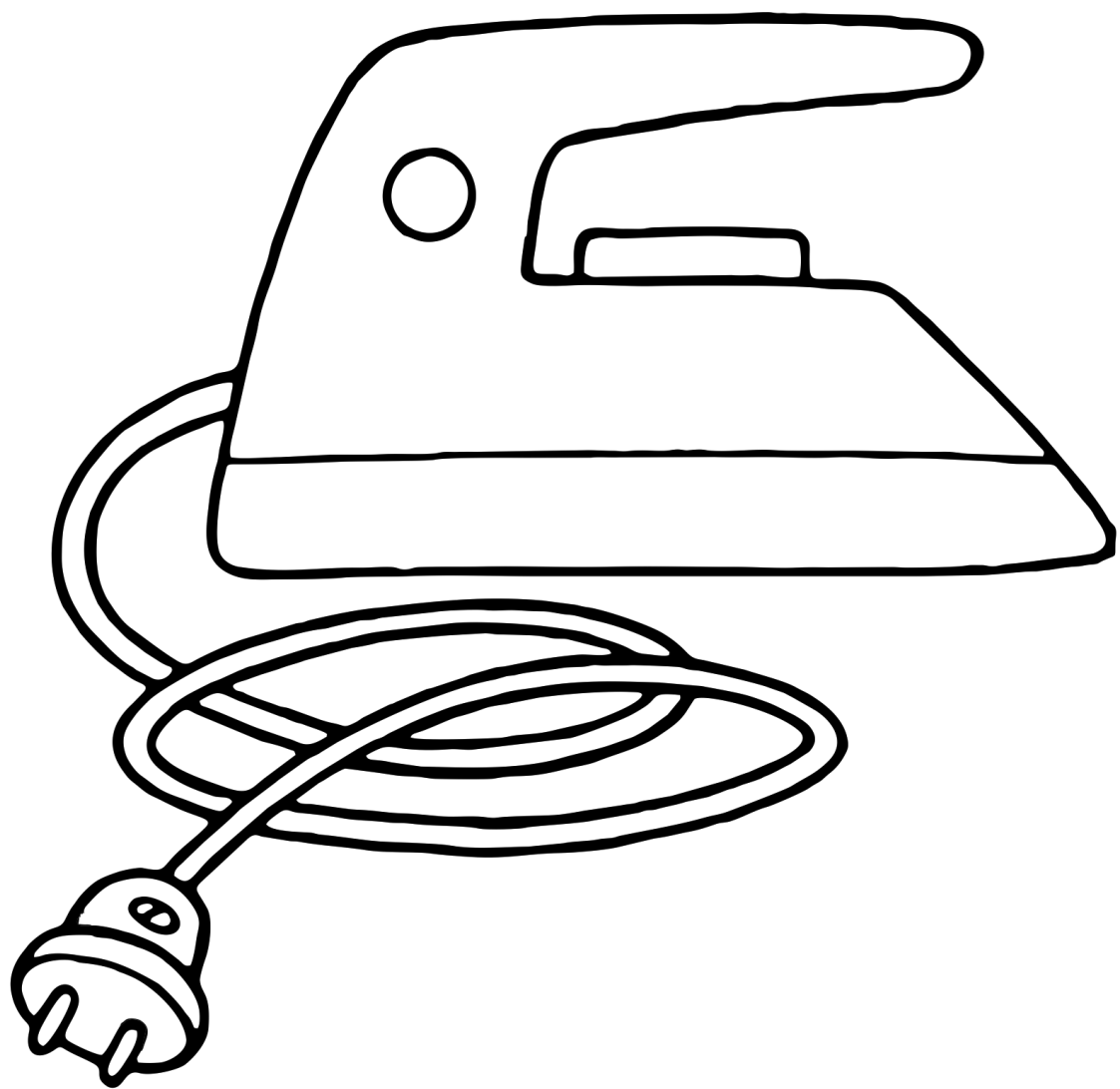

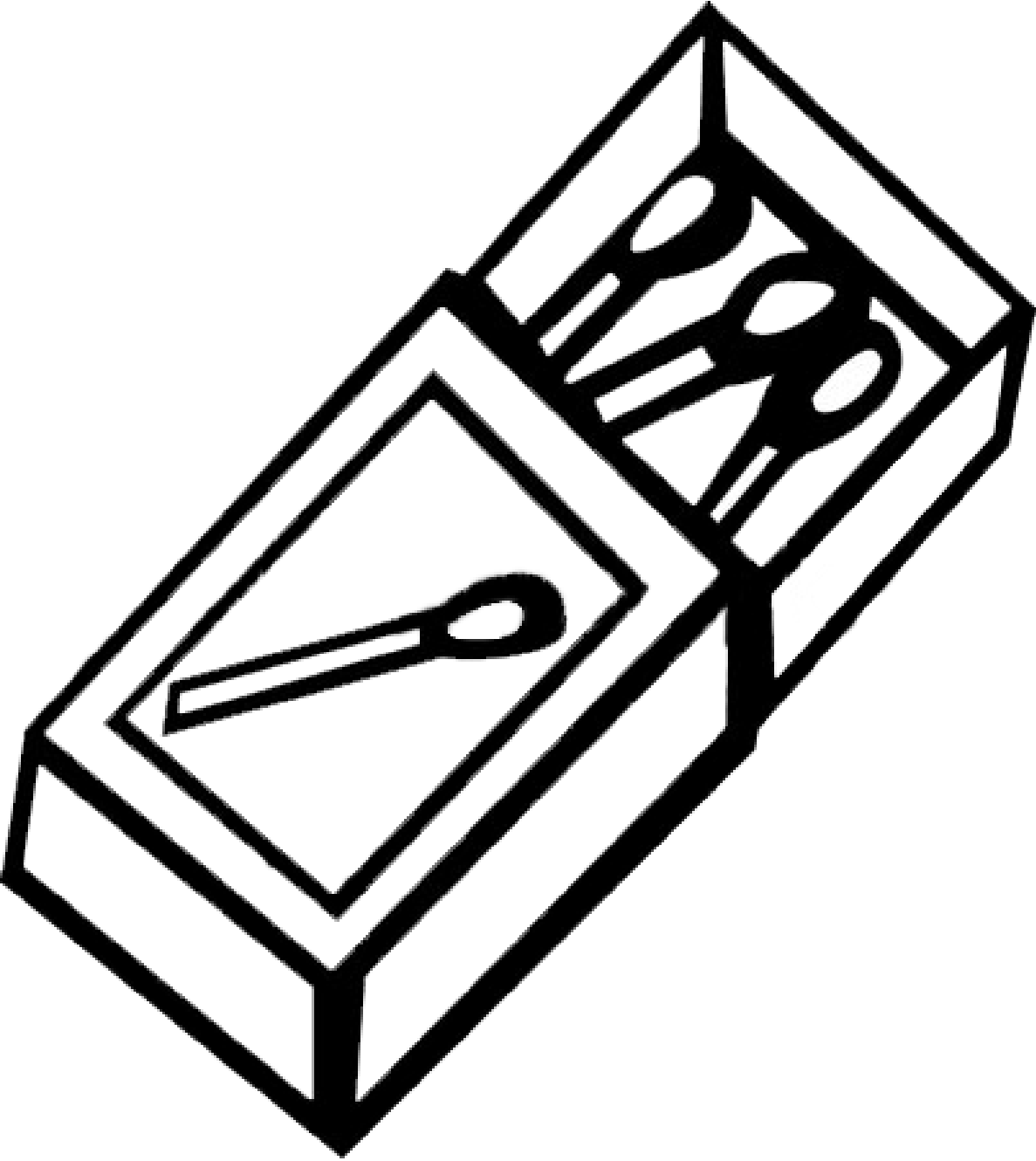



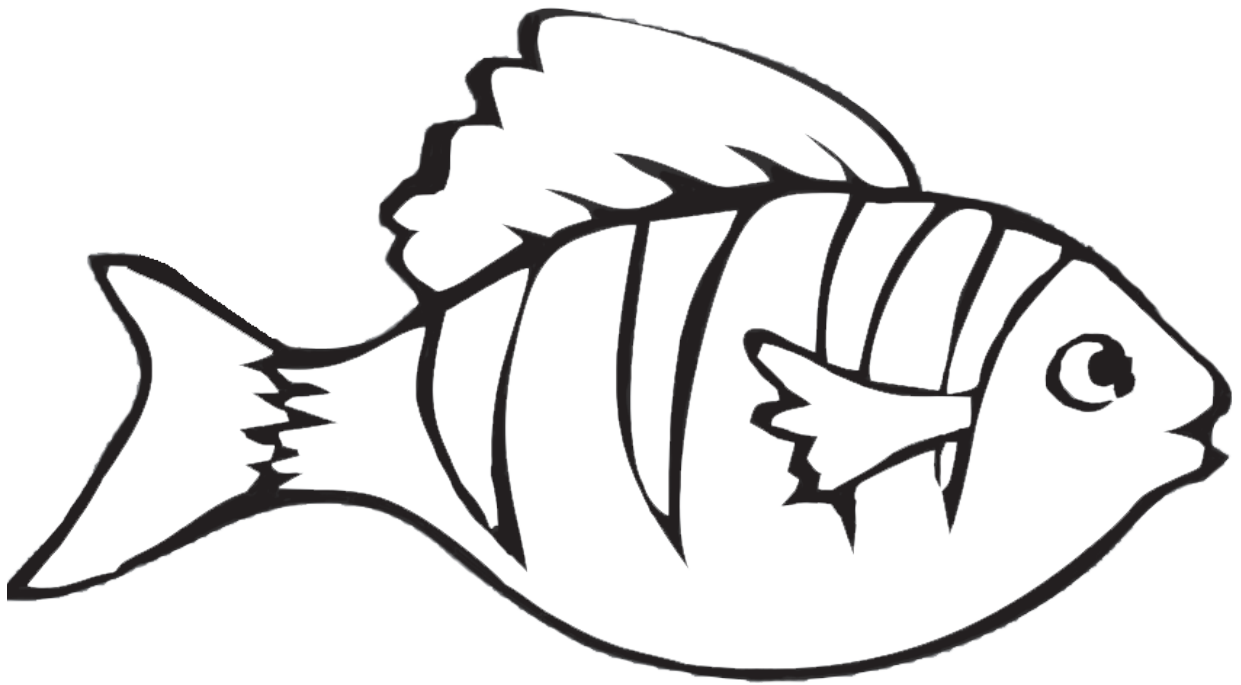



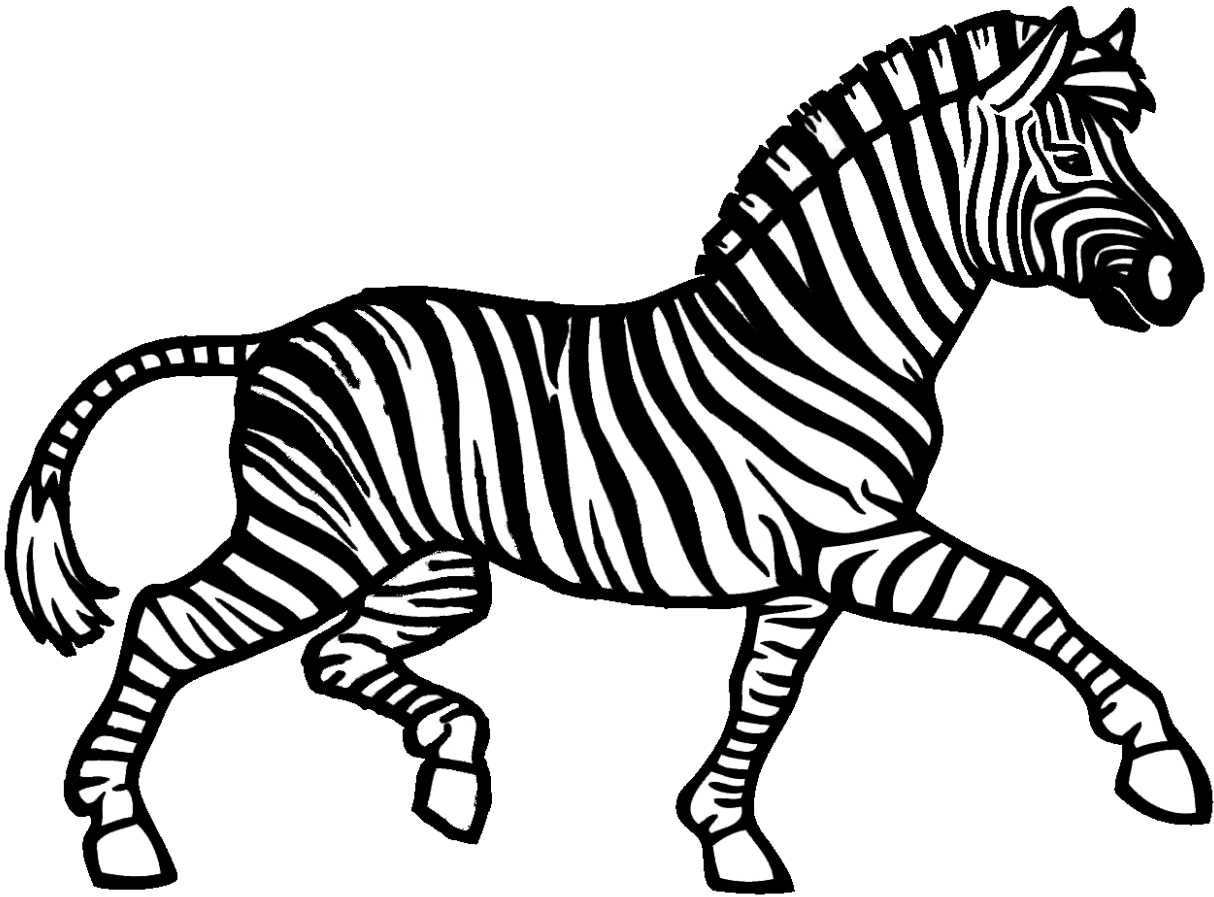



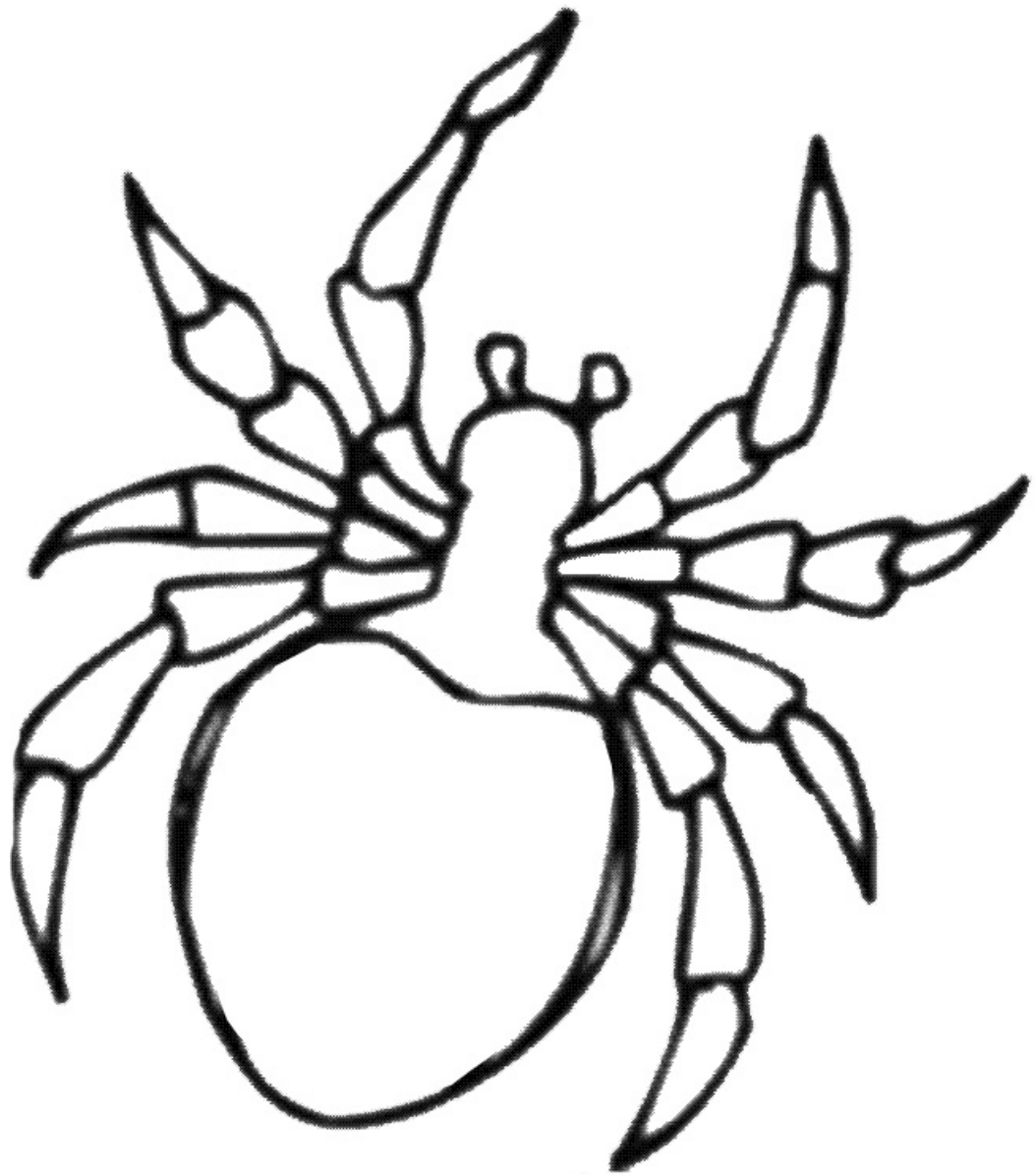

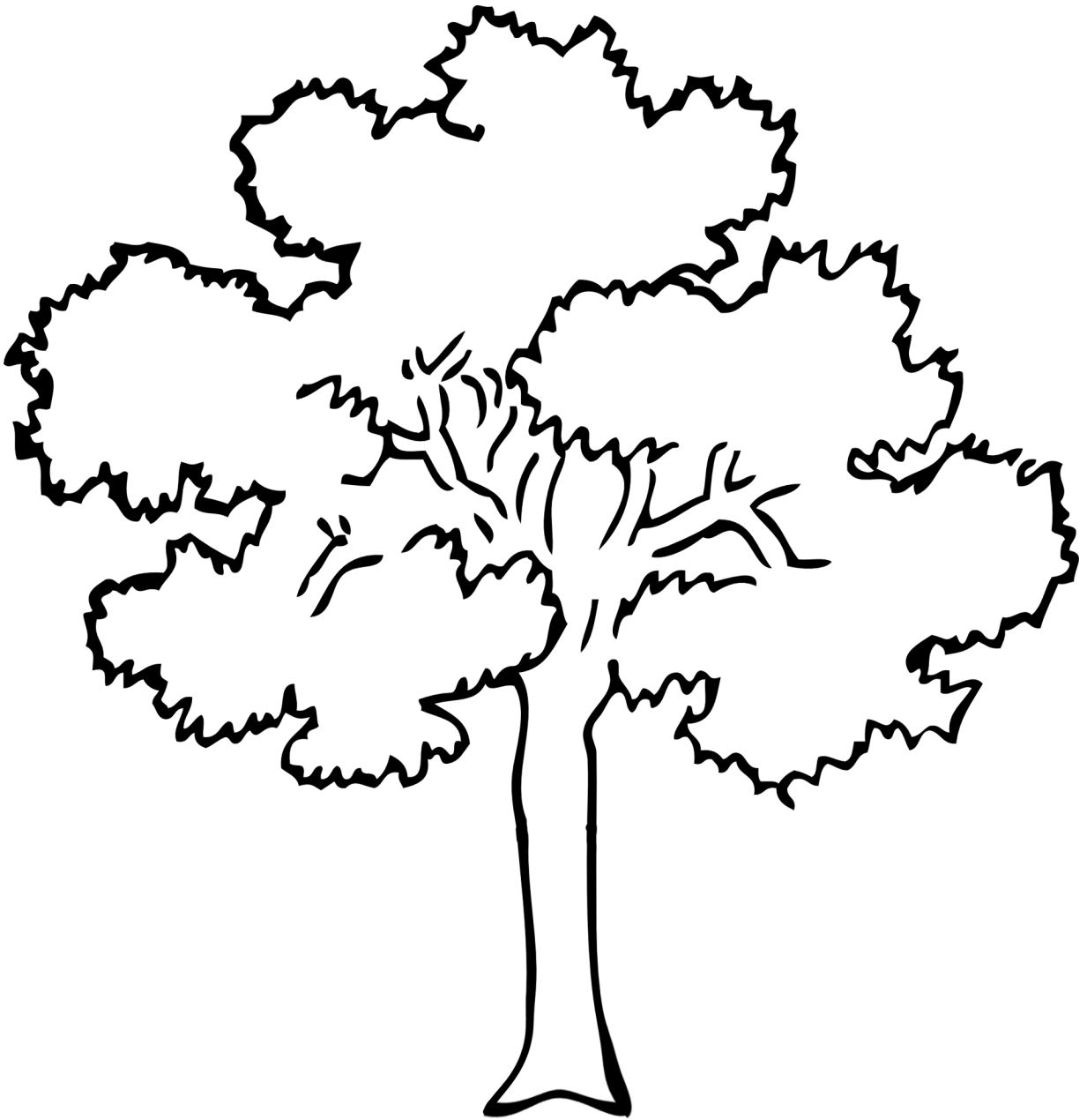

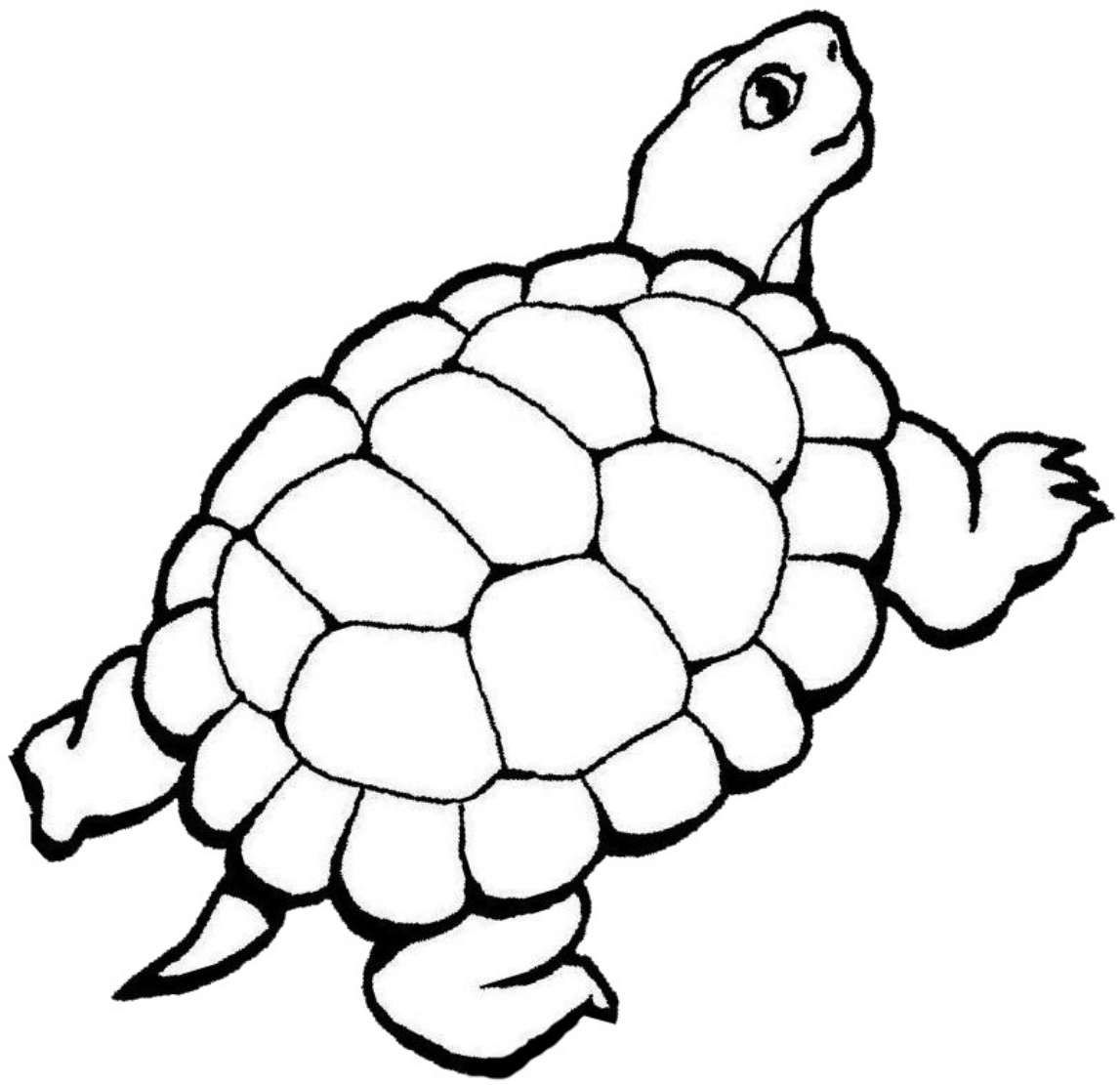

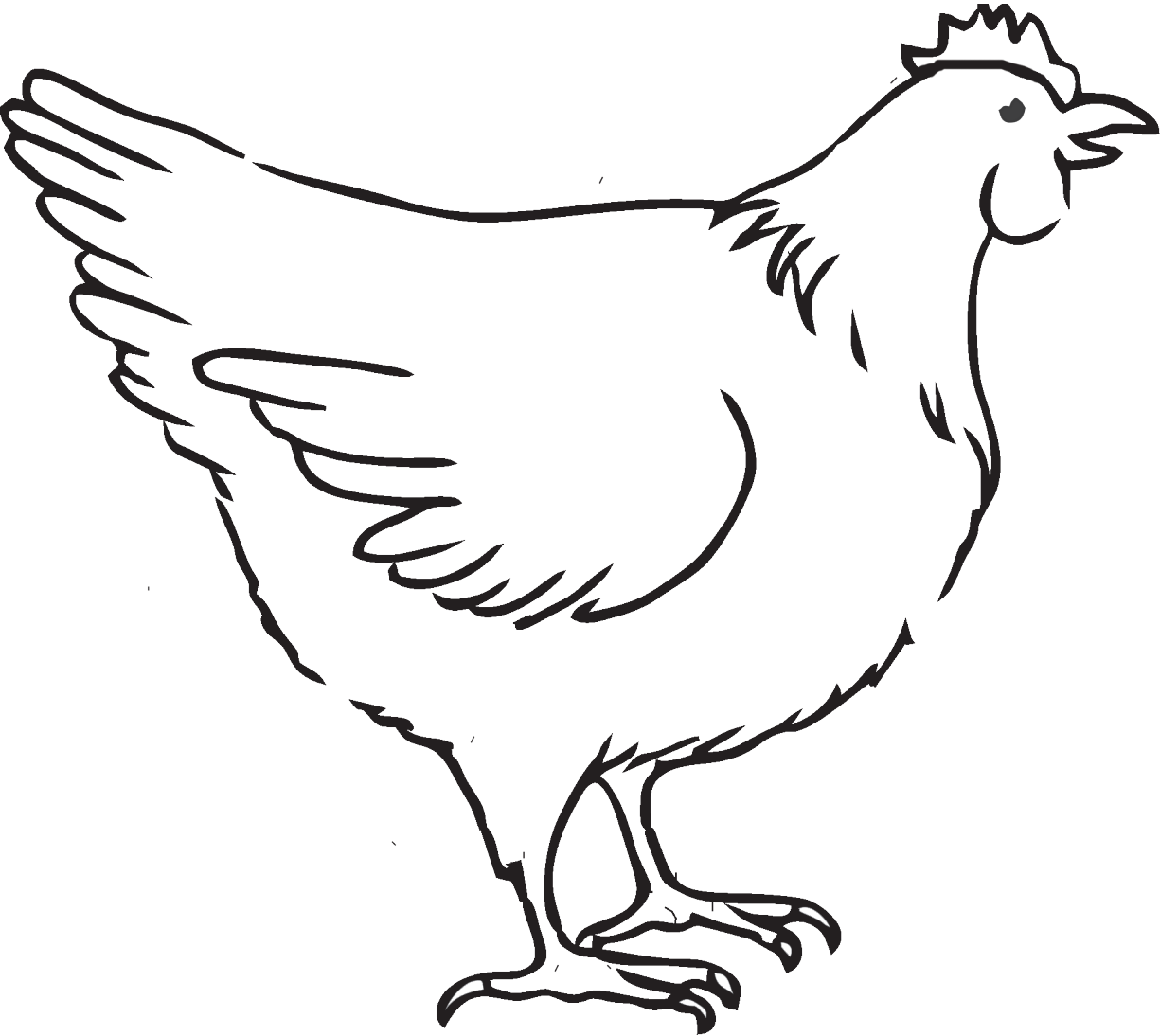

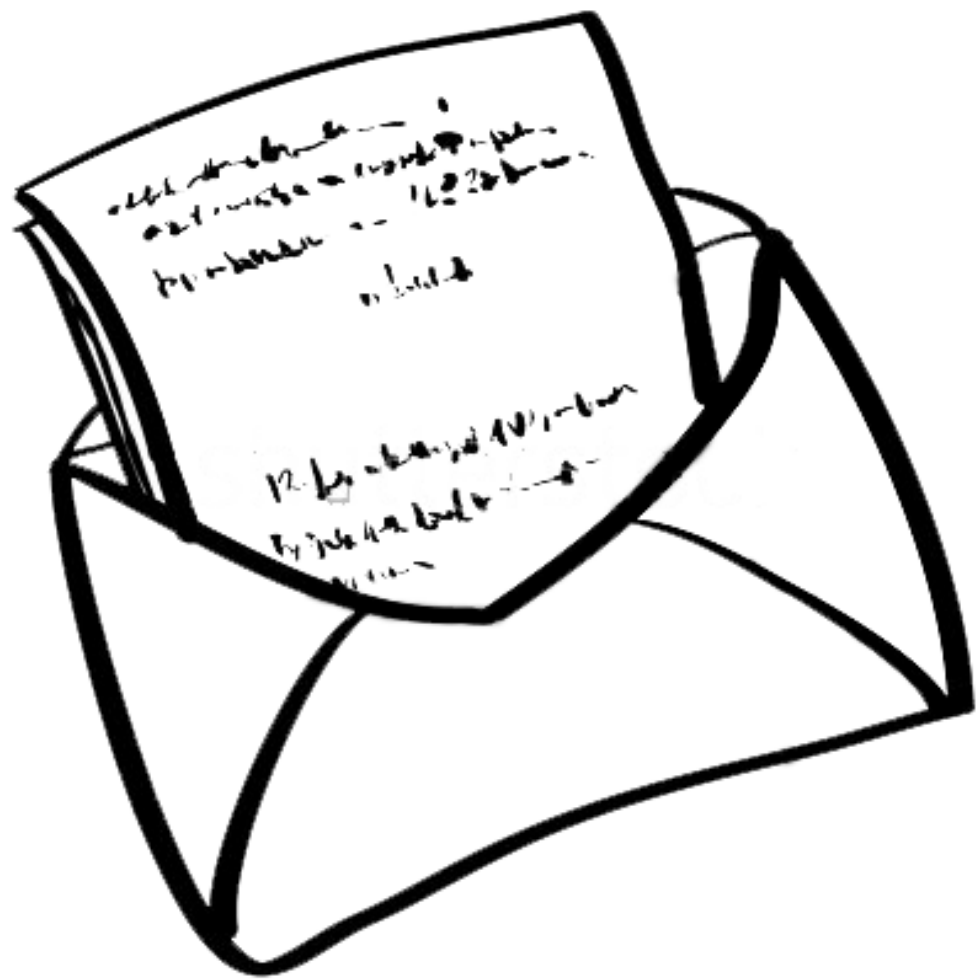

add address -  
at - 1234 - 5678  
number - 12345678  
street

1234567890  
1234567890

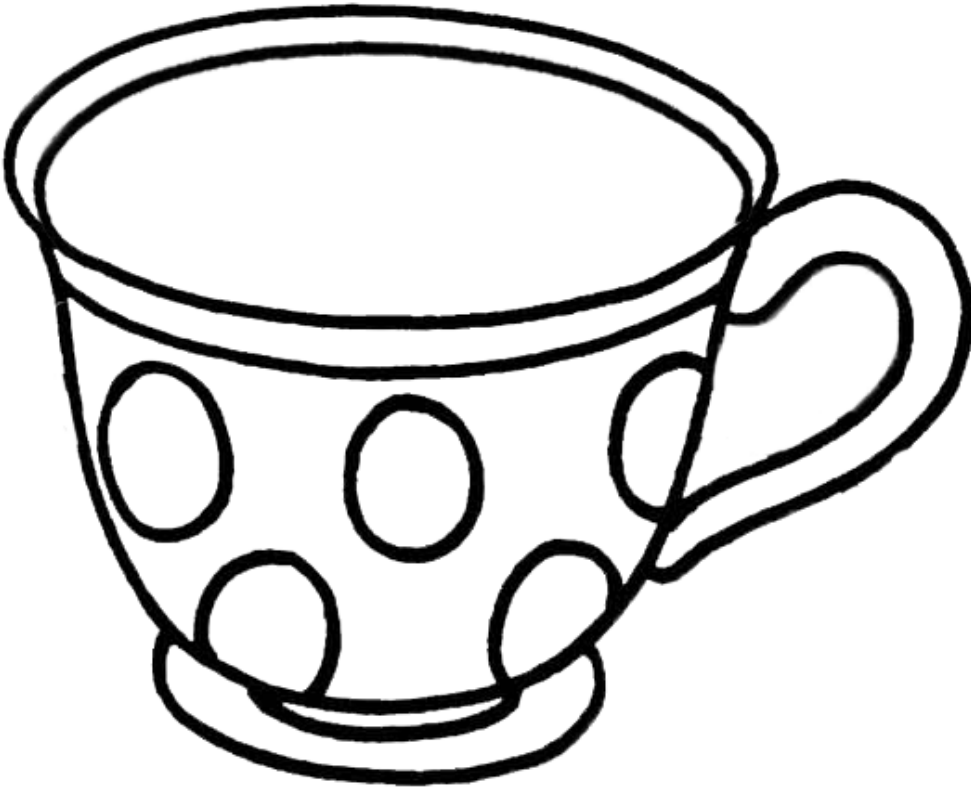



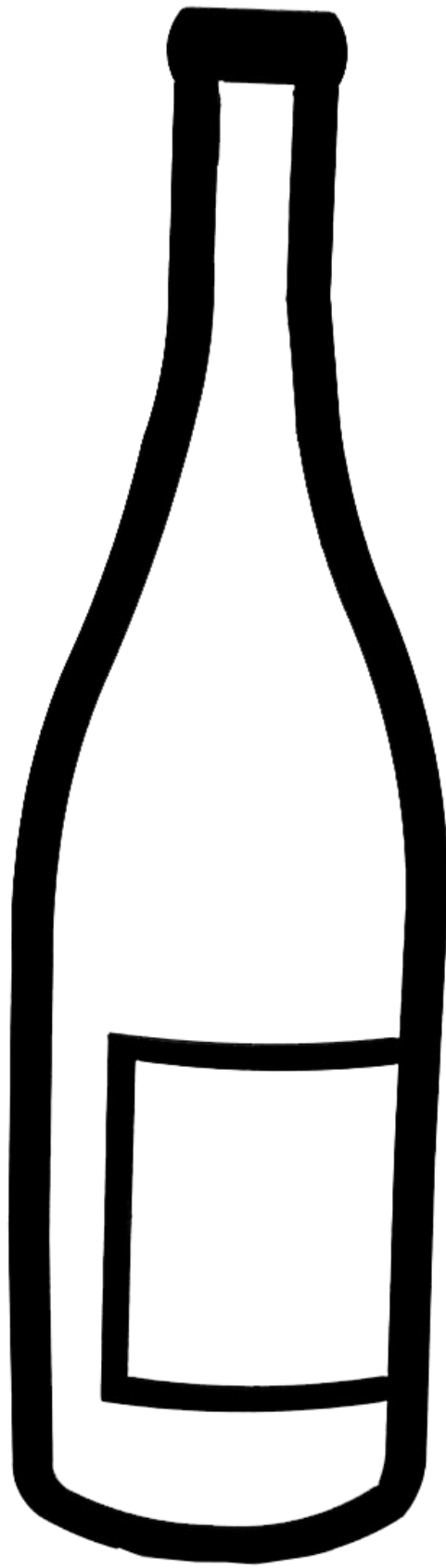

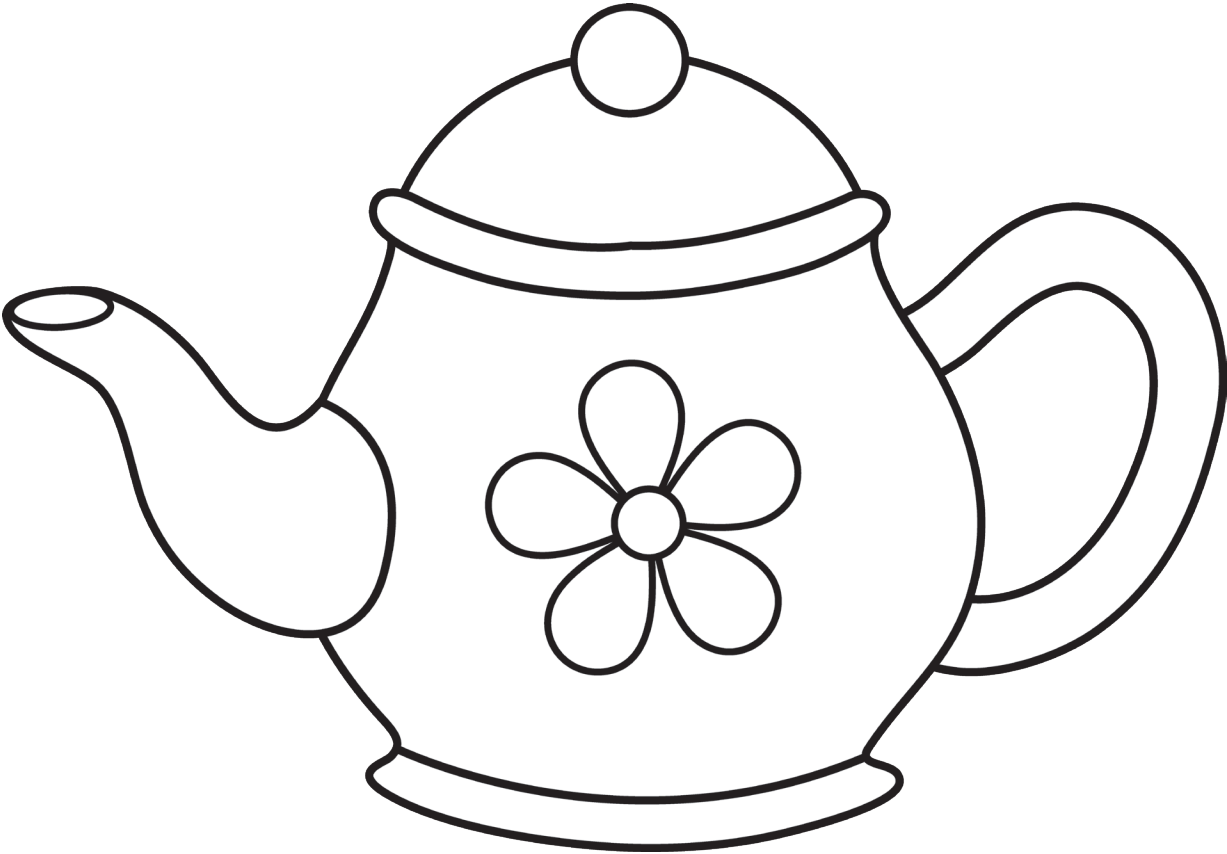



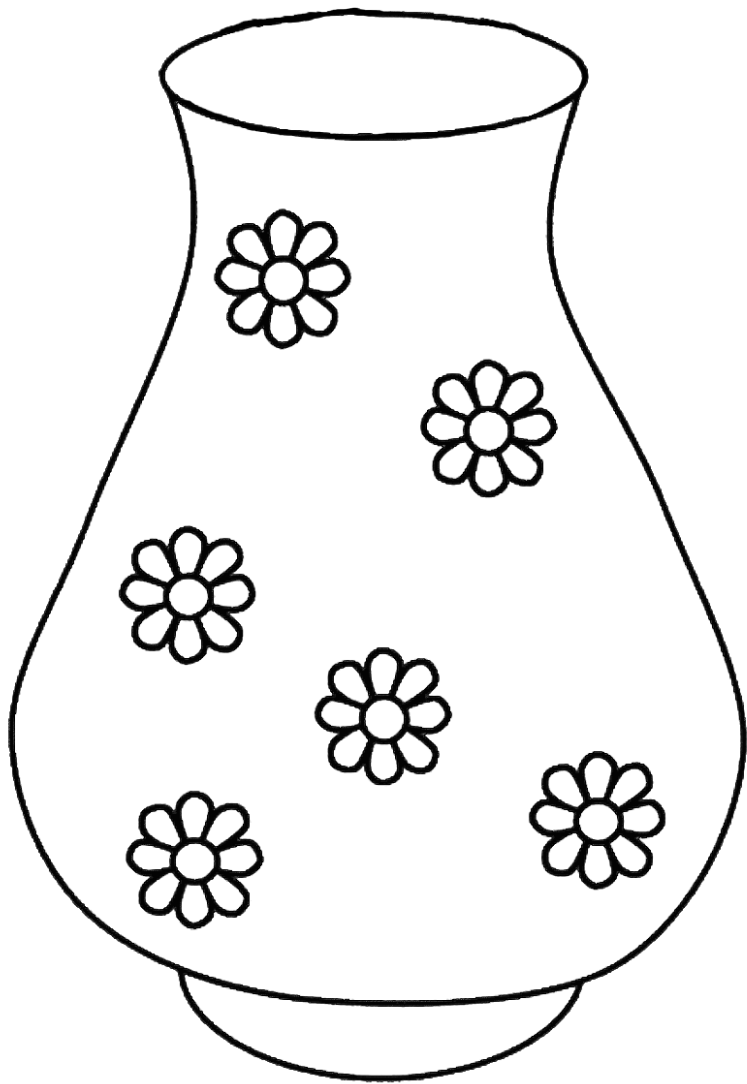

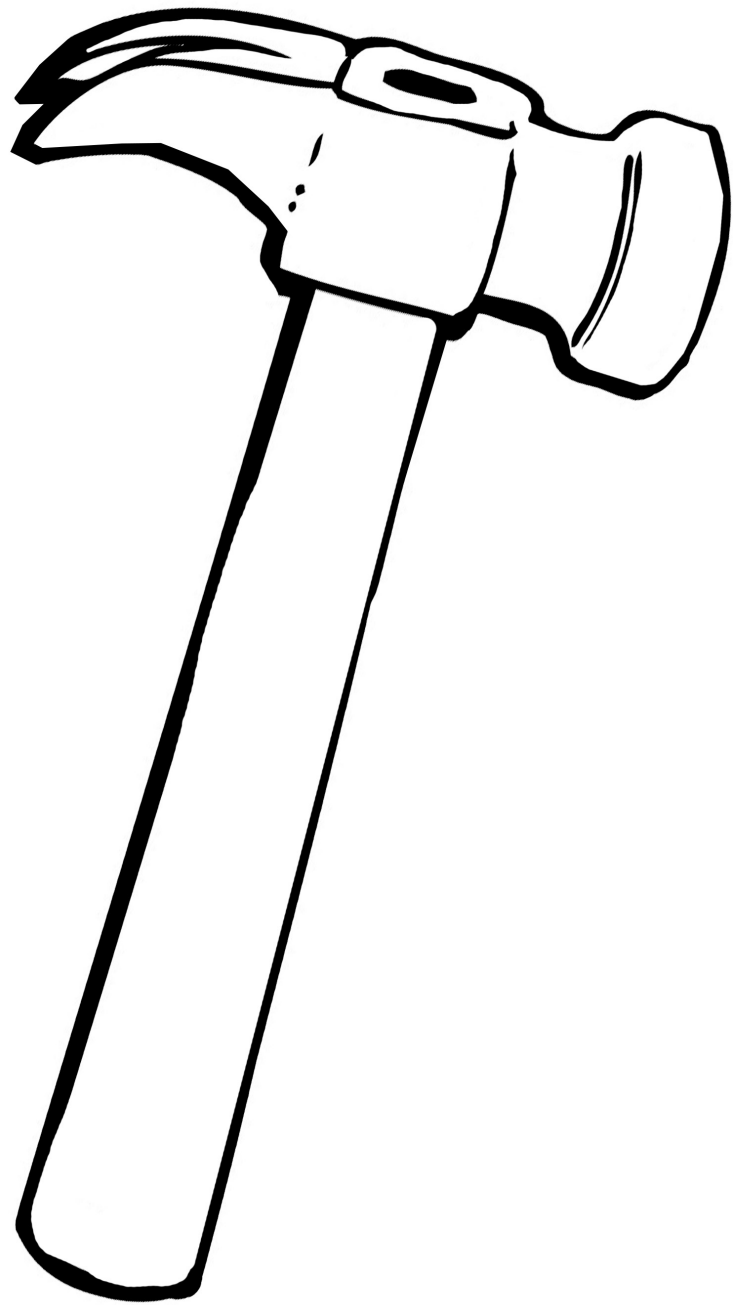

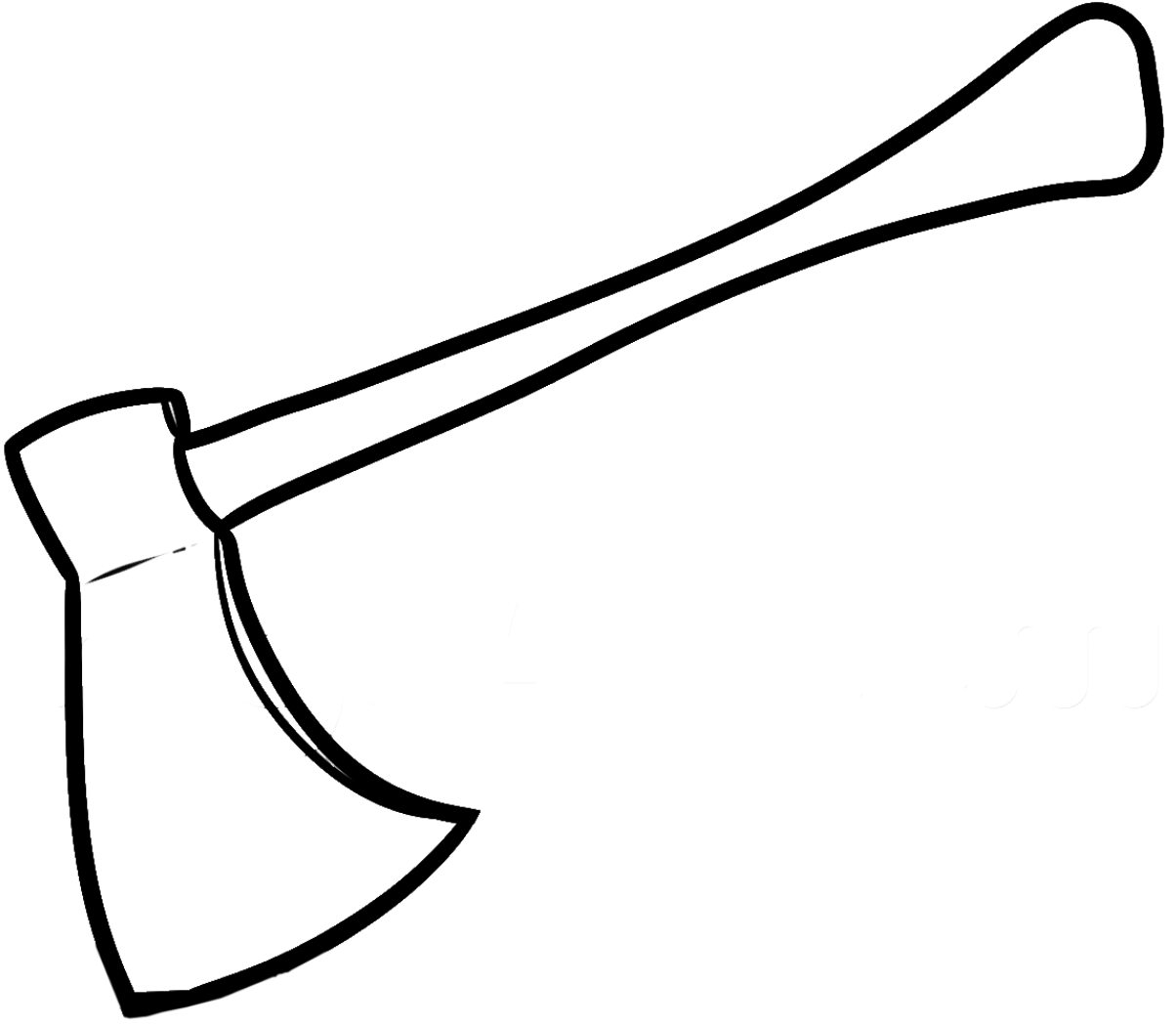

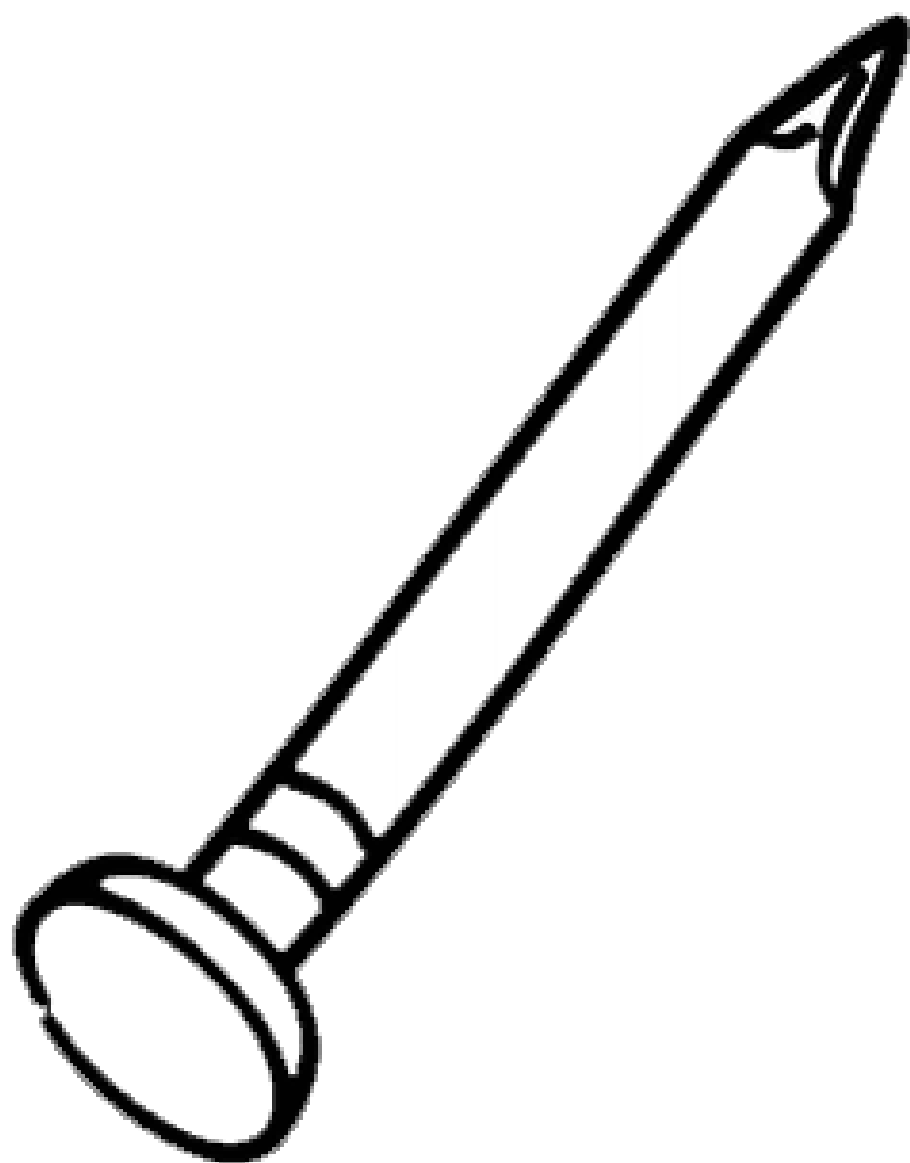

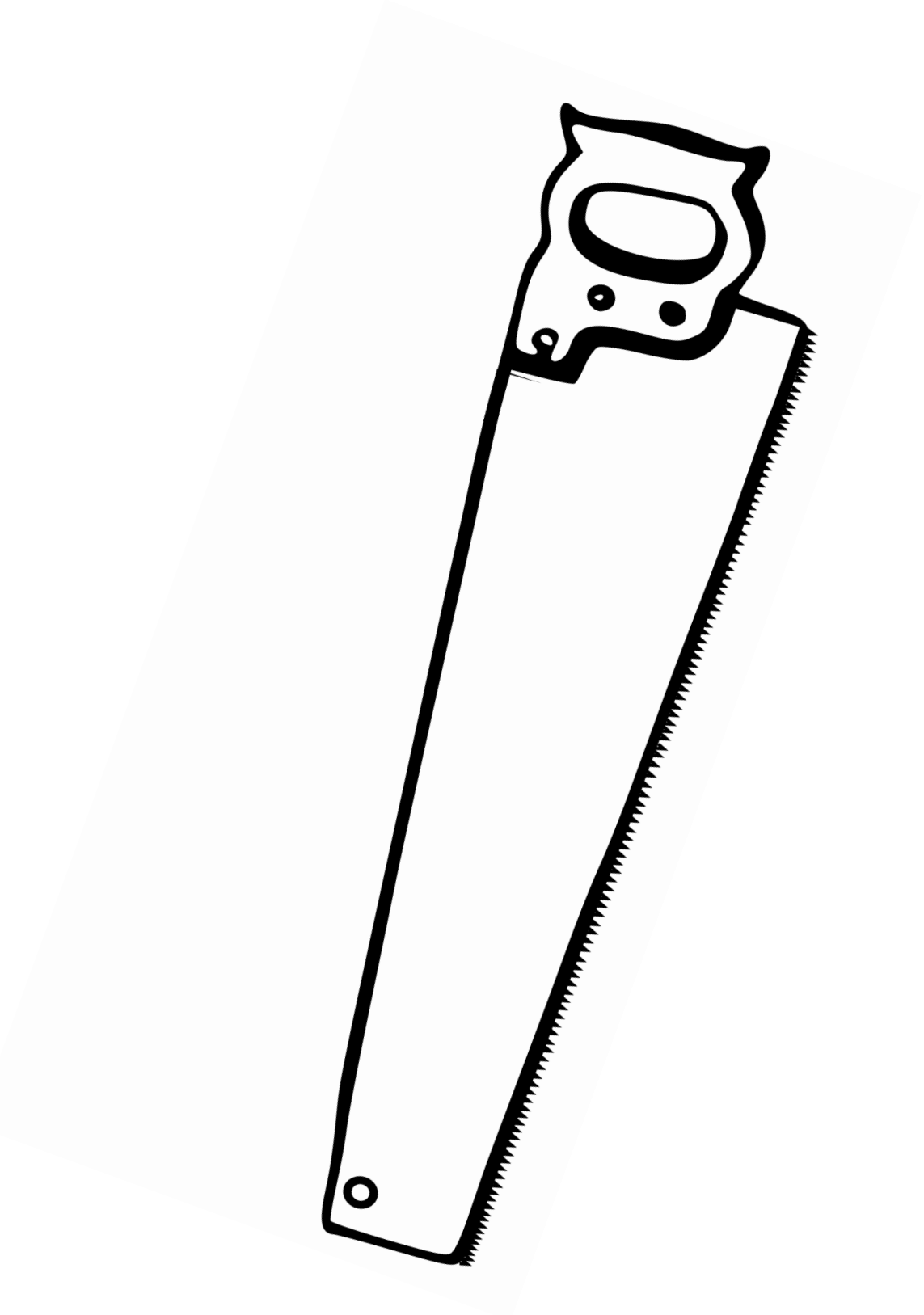



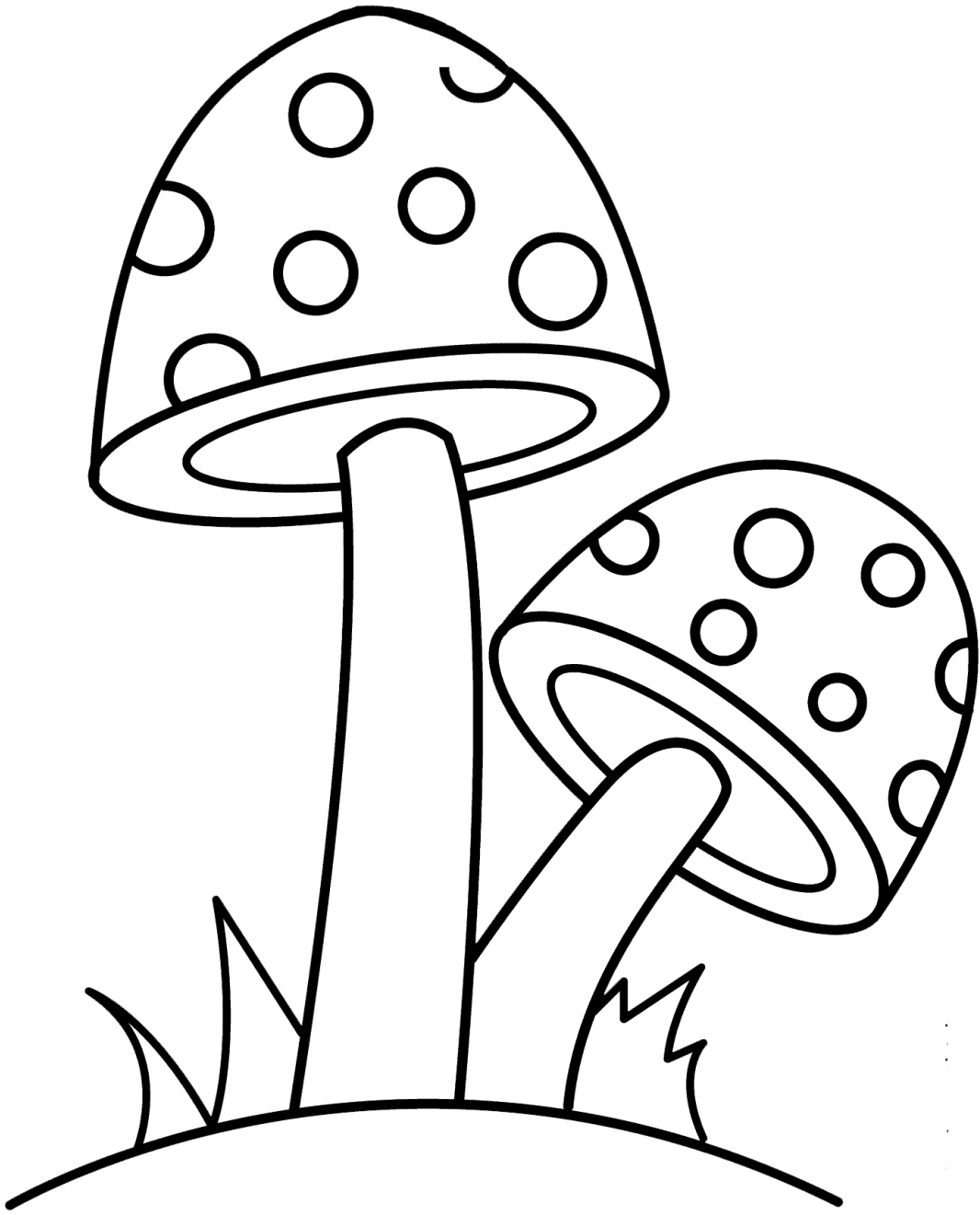

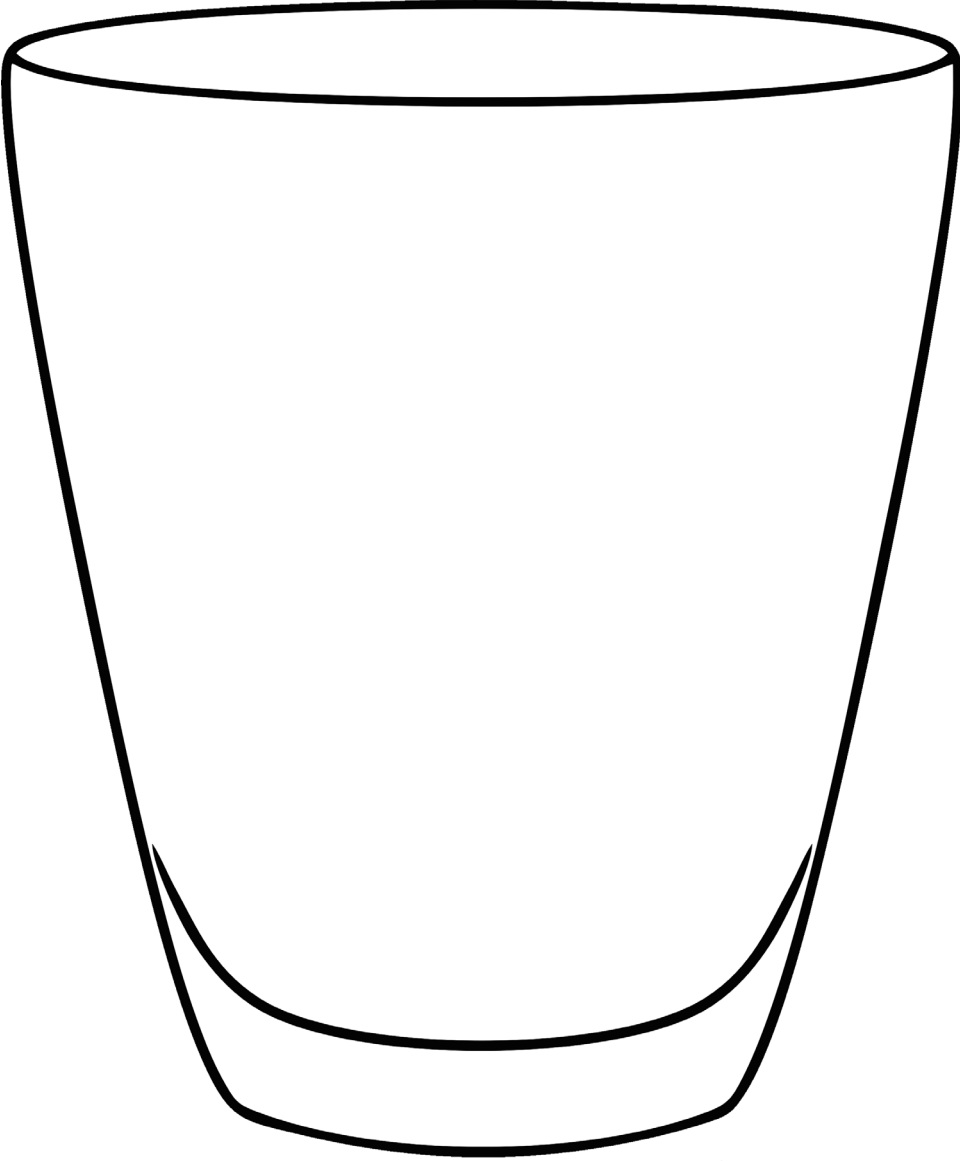

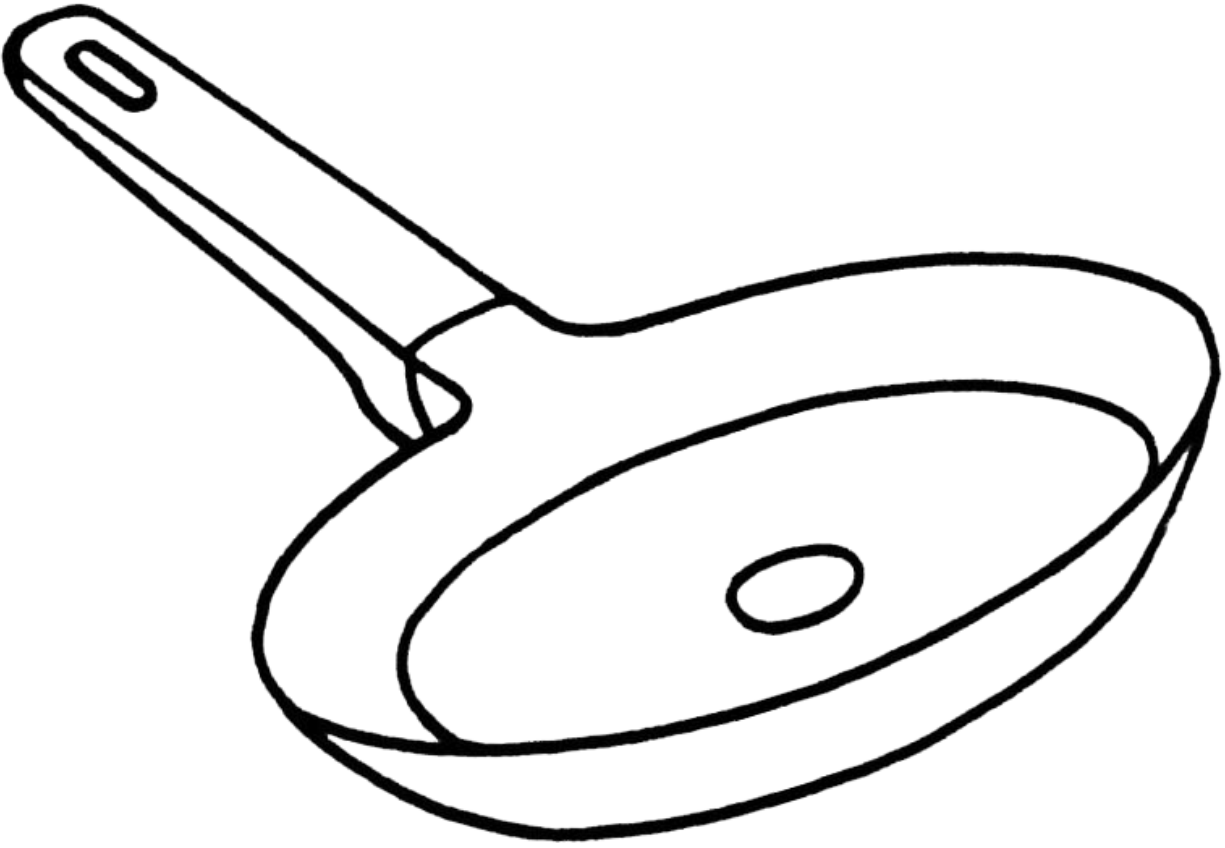

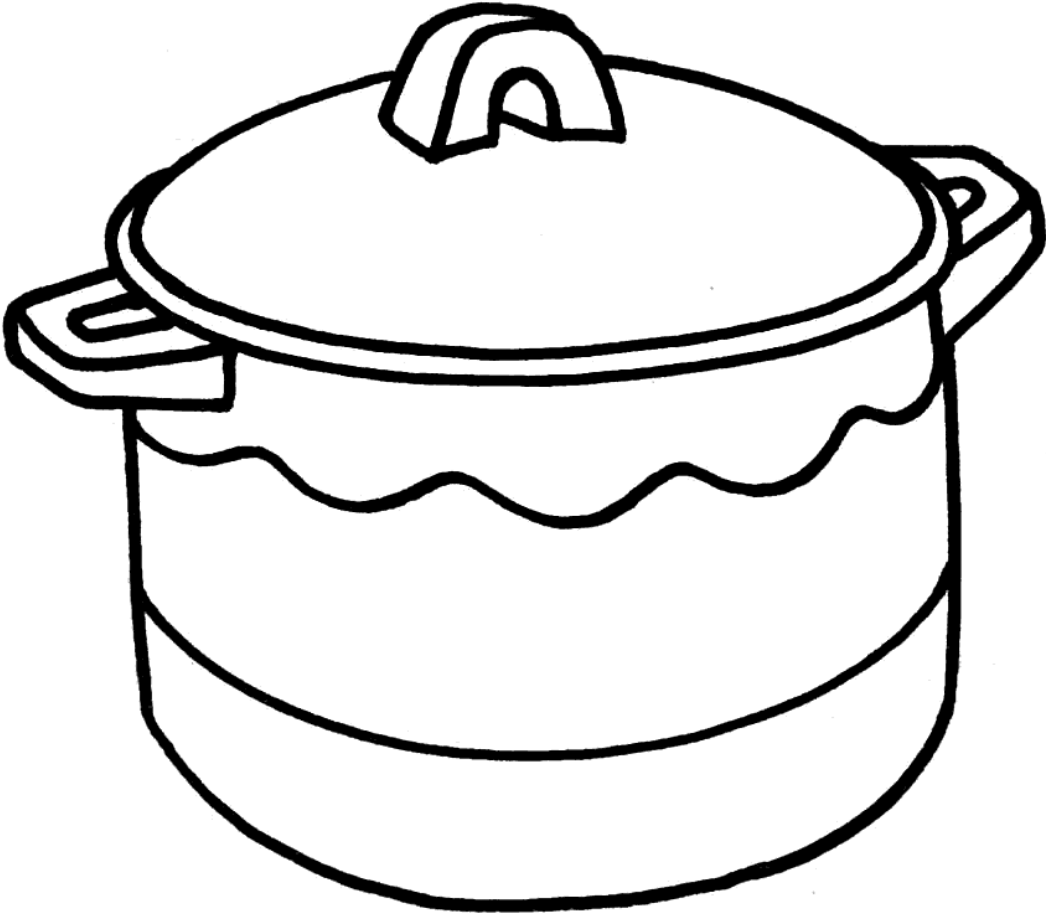

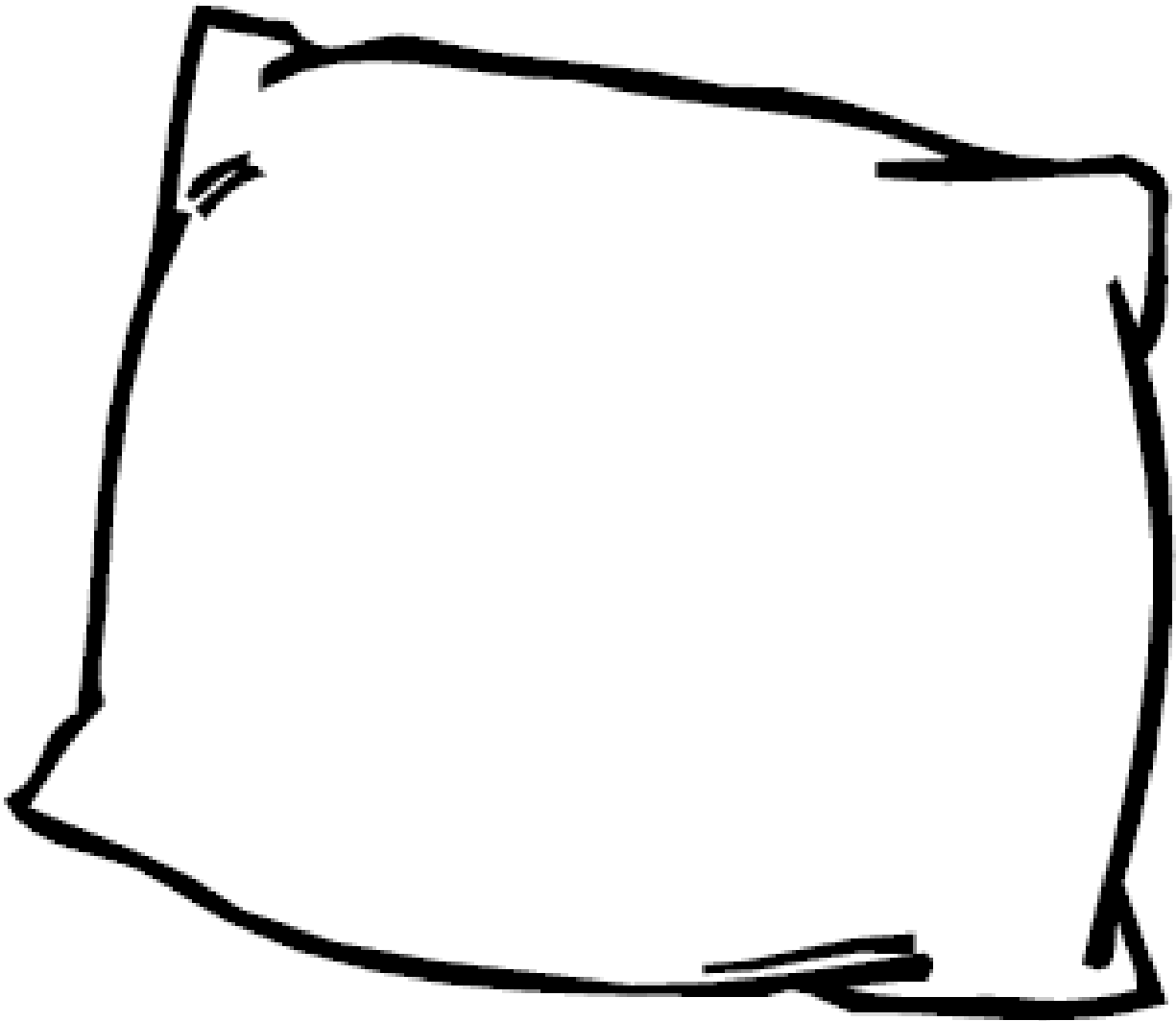

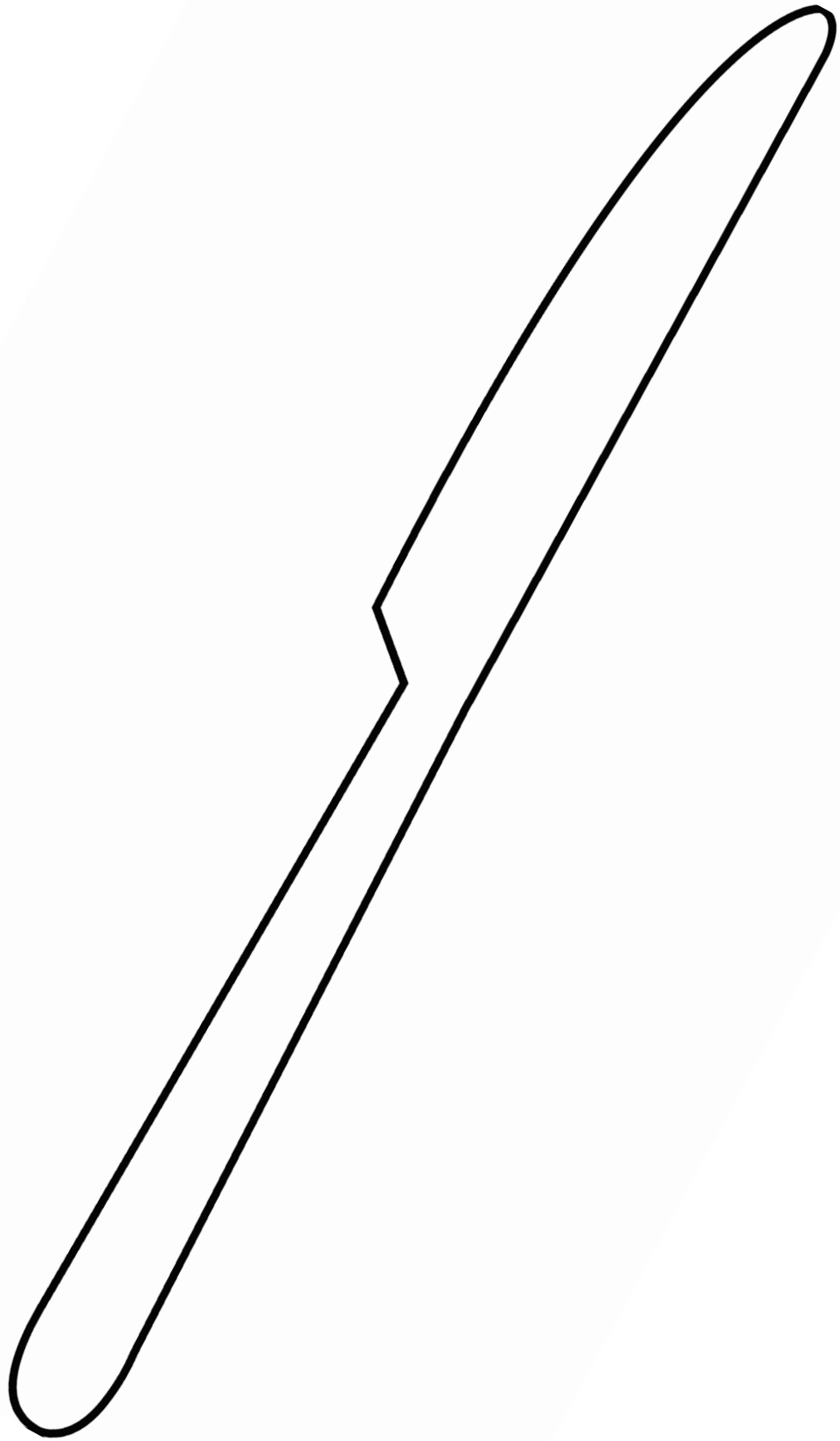

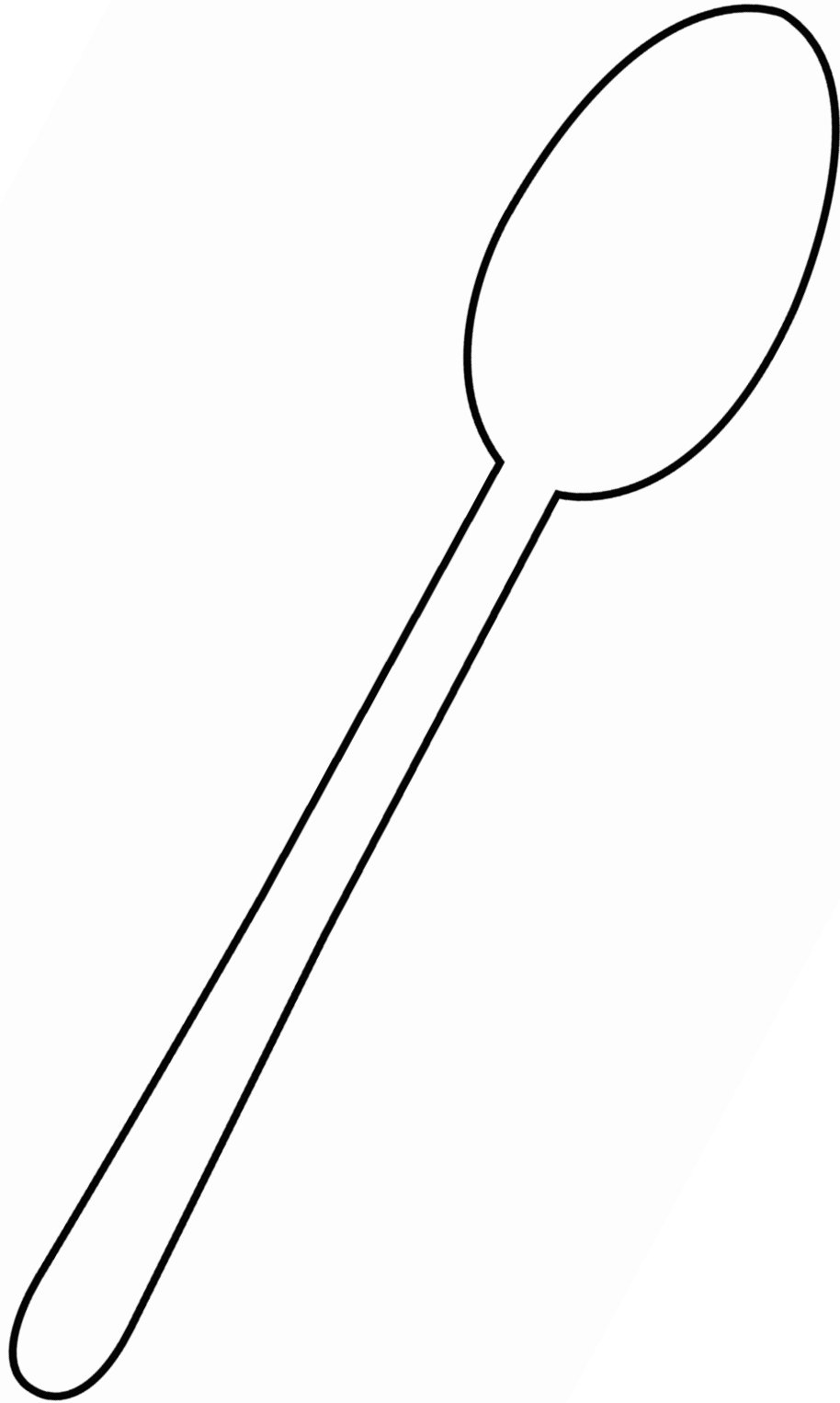

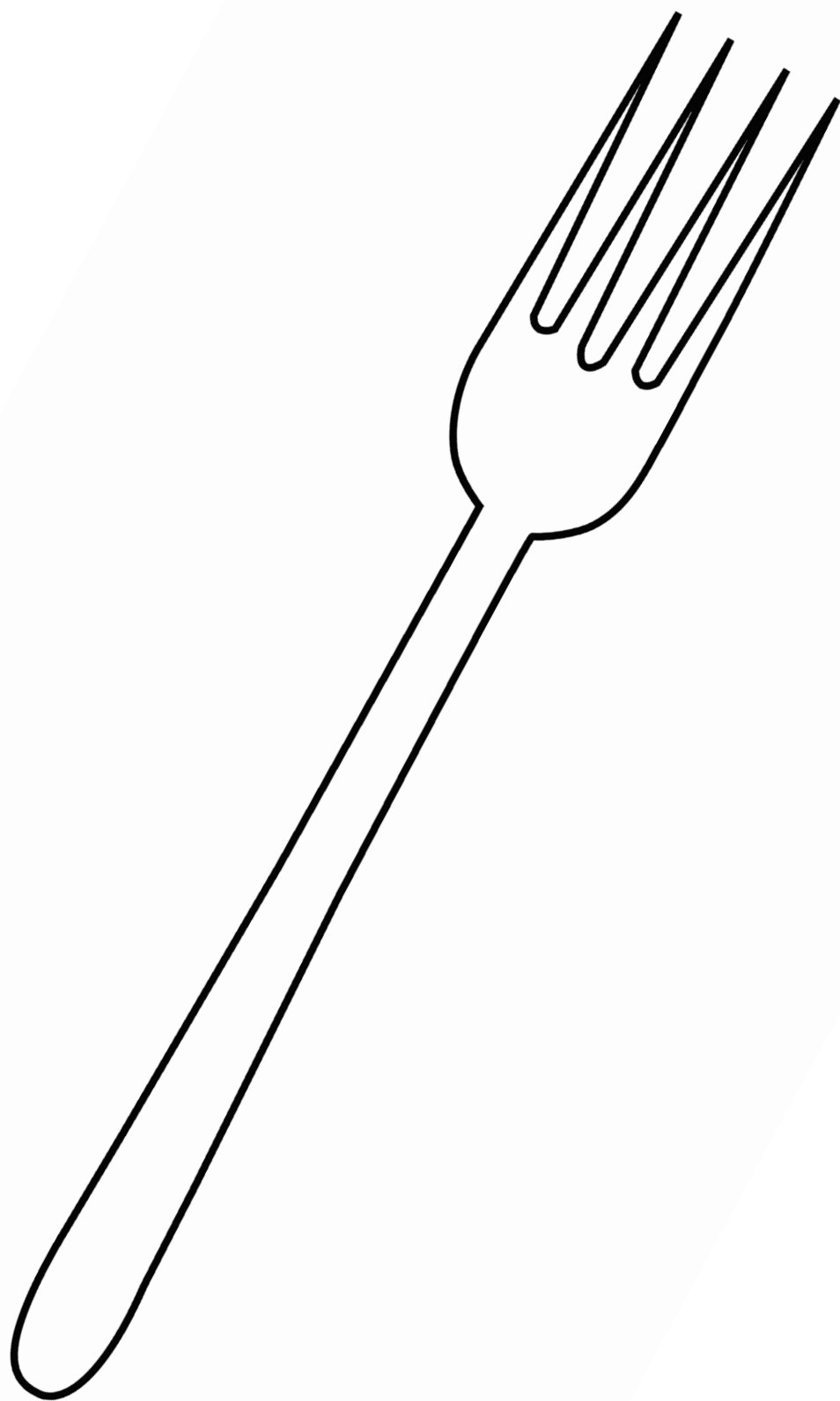



1

2

3

4

5

6



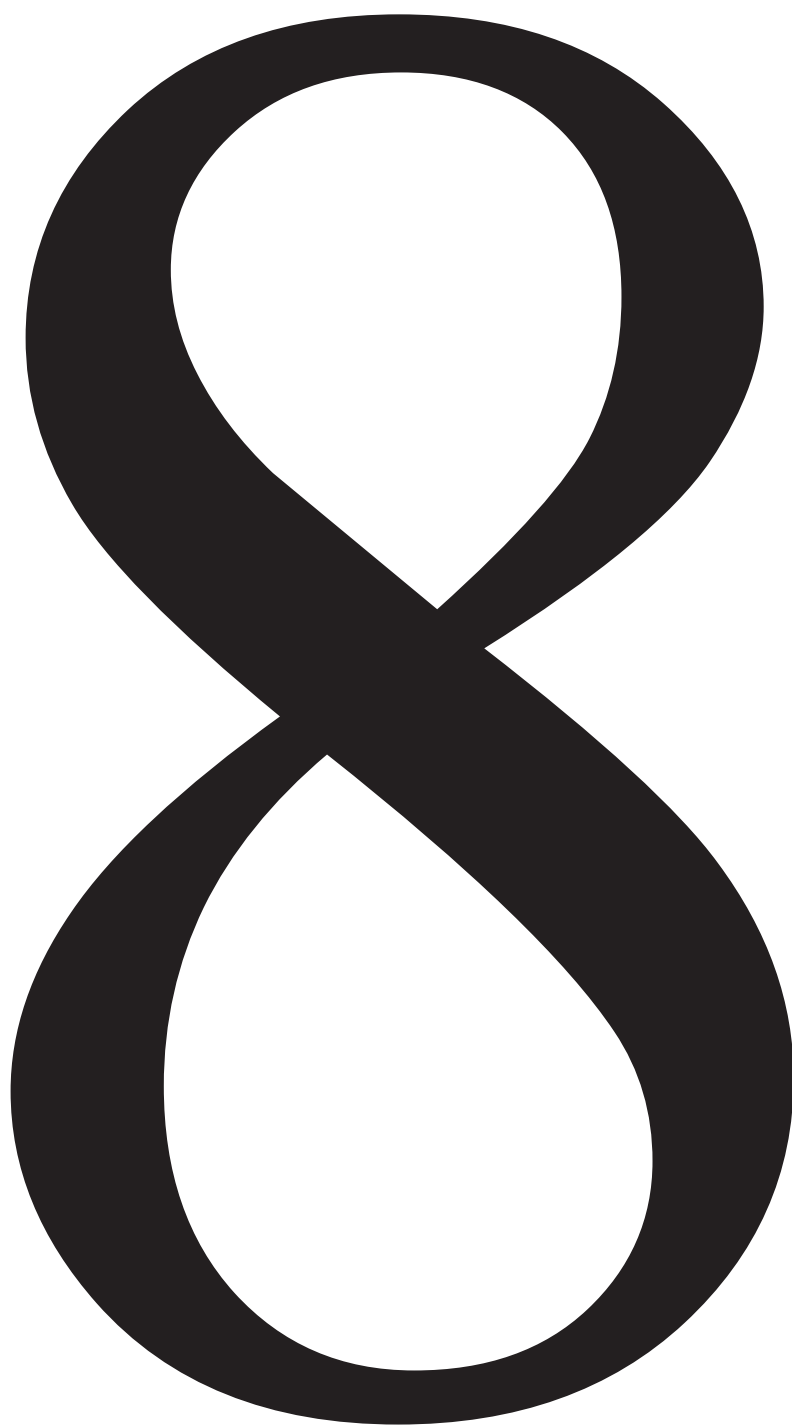



9

10

